

interstuhl



/ SILVER



NEUGIER

CURIOSITY
CURIOSITE
NIEUWSGIERIGHEID
INQUIETUD
CURIOSITA

d_Es ist die Neugier, etwas nie da Gewesenes zu schaffen.

Mode diktiert, Moderne macht frei. Neue Gedanken werden in einem freien Geist gedacht. Die Freude und die Neugier auf das Ergebnis einer neuen ästhetischen Form und Funktion ist die Triebfeder von Silver.

Das Produktdesign Silver kommt aus der Arbeit und schlägt die Brücke ins Lebhaftes, ins Private und Stille. Wir wollten ein Nutzobjekt schaffen, das sich überall und in vielen Formen einfinden, einfügen, oder solitär wirken kann. Das durch Beschaffenheit, Kurven und Details zum Befühlen reizt. Die Silver Familie wurde um viele Ideen und Gedanken bereichert. Es macht Freude zu sehen, wie jedes einzelne Produkt Szenarien verändert und wiederum neue Eindrücke entstehen.

gb_It is curiosity that leads to the creation of something that has never been seen before.

Fashion is dictatorial, modernity is liberating. Freedom of spirit encourages a new way of thinking. The driving forces behind Silver are enjoyment and the curiosity to achieve a new aesthetic form and function.

Finding its origins in an office environment, the Silver product design has been designed equally for community and privacy. It was our aim to create an object which, in its many guises, can be an integral part of or a perfectly matched addition to any location – and has just as much impact when standing alone. An object whose quality, curves and details will cause a real stir. The Silver family has been enriched with many ideas and thoughts. It is a joy to see how each individual product can change any setting, leaving a new mark every time.

fr_Curiosité de l'inventeur à la recherche de l'inédit.

La mode ordonne, la mode libère. Les idées nouvelles surgissent dans l'esprit libre. Le plaisir de la recherche esthétique et la curiosité face à l'inédit sollicitent les créateurs de Silver.

Le design de produit Silver, émanation du travail, tisse le lien entre l'animation, le monde personnel jusqu'au recueillement. Nous créons un objet utile, adapté à tous les cadres, dont la multitude des formes sait s'intégrer à un ensemble ou se présenter en solitaire. Sa texture, ses lignes et ses détails incitent au toucher. La gamme Silver s'est enrichie de tant de représentations et d'idées. Les objets se mettent en scène, chacun selon son mode, et produisent des impressions sans cesse inédites.

nl_Het is de nieuwsgierigheid om iets te creëren dat er nog nooit is geweest.

Mode dicteert, moderne kunst bevrijdt. Nieuwe gedachten ontstaan in een vrije geest. Het plezier van, en de nieuwsgierigheid naar nieuwe esthetische vormen en functies zijn de drijfveren van Silver.

De productontwerpen van Silver zijn het resultaat van intensief denkwerk en slaat een brug naar het levendige, de privésfeer, de stilte. Wij wilden een gebruiksvoorwerp creëren dat overall en in talrijke vormen kan worden ingepast, maar ook op zichzelf helemaal tot zijn recht komt. Een product dat er met zijn kwaliteit, vormgeving en details om vraagt te worden aangeraakt. De Silver-collectie is met vele ideeën en gedachten verrijkt. Het is een genoegen te zien hoe elk afzonderlijk product interieurs verandert met telkens weer nieuwe indrukken.

es_Es la inquietud de crear algo nuevo, nunca visto.

La moda dicta, la modernidad libera. Nuevos pensamientos se engloban en un espíritu libre. La alegría y la inquietud del resultado de una nueva forma y función estéticas son el impulso de Silver.

El diseño de los productos Silver se basa en el trabajo y hace saltar la chispa hacia lo vivaz, lo privado y la calma. Queríamos crear un objeto utilitario que pudiera integrarse en todas partes y en muchas formas o que pudiera transmitir una sensación solitaria. Cuya consistencia, curvas y detalles inviten a tocarlo. La familia Silver ha sido enriquecida con muchas ideas y reflexiones. Da gusto ver cómo cada uno de los productos cambia escenarios, creando nuevas sensaciones.

it_È la curiosità di creare qualcosa che prima non c'era.

La moda detta, l'attualità libera. Le nuove idee nascono da uno spirito libero. La gioia e la curiosità per il risultato di una nuova forma estetica e di una funzione costituiscono la forza propulsiva di Silver.

Il design del prodotto Silver trae origine dal mondo del lavoro e getta un ponte nella vitalità, nel privato e nella tranquillità. La nostra intenzione era di creare un oggetto d'utilità che si potesse adattare ovunque e a numerose forme, inserire in un contesto o agire da solo. La cui conformazione, le cui curve e i cui dettagli invogliano a toccarlo. La famiglia Silver è stata arricchita di numerose idee e concetti. È una gioia vedere come ogni singolo prodotto modifica gli scenari e come nascono sempre nuove impressioni.



d_Helmut, Werner, Joachim Link, Inhaber und Geschäftsführer Interstuhl.

Das Zusammenspiel unserer Studien und des langjährigen Wissens gehen in Silver auf. Interstuhl ist seit bald 50 Jahren auf die Entwicklung des gewinnbringenden Sitzens menschgerechter und form-schöner Produkte spezialisiert, in steter Suche nach dem qualitativen Meisterwerk. Ist eines vollbracht, muss ein Nächstes folgen. Innovation entsteht in Unternehmen, die eine eigene Politik werthalten und verfolgen. Unser Unternehmen muss frei von Konventionen bleiben, um lebhaft in der Entwicklung den Menschen zu dienen.

gb_Helmut, Werner and Joachim Link, proprietors and directors of Interstuhl.

Silver represents the fusion of our studies and many years of knowledge. Specialising in the development of products made for and matched to people for almost 50 years, Interstuhl never strays from its quest to achieve the quality and beauty of a masterpiece. The creation of one generates the search for the next. Innovation occurs in organisations which define and are true to their own values and beliefs. In order to serve mankind by means of active design and development, our organisation cannot and will not be bound by conventions.



Hadi Teherani, Architekt und Produktdesigner.

Form muss das Wesen des Materials und des Nutzens emotional erreichen; Schicht um Schicht muss der Kern der Bedeutung zunächst freigelegt werden, um das Wesentliche zu fassen, und dann einen neuen Kontext zu finden. Ziel war, die technische Komplexität von Silver unsichtbar werden zu lassen, die poetische Ebene perfekten Sitzens zu erreichen. Ein Stuhl, der nur im Büro zu gebrauchen ist, ist zu wenig. Ästhetik ohne Ethik ist Täuschung.

Hadi Teherani, architect and product designer.

Design needs to make an emotional connection with the character of materials and their use; layer by layer must be peeled away in order to reach the heart of the meaning and discover a new context. It was our aim to make the technical complexity in Silver invisible and reach the poetic plateau of perfection in seating. A chair which is only suitable for use in an office is not enough. Aesthetics without ethics is deception.

fr_Helmut, Werner et Joachim Link, propriétaires et gérants d'Interstuhl.

Notre étude et notre savoir, recueilli au cours de longues années d'expériences, trouvent leur expression dans Silver. Depuis près de 50 ans Interstuhl est spécialisé dans la conception de sièges ergonomiques ; le fruit de cette spécialisation se reconnaît à la beauté des lignes et à la maîtrise de la réalisation, objet de notre recherche permanente de la qualité. L'accomplissement n'est pas une fin, mais la voie ouverte vers de nouvelles réalisations. L'innovation a lieu dans l'entreprise, fidèle à son système de valeurs. Notre entreprise doit s'affranchir du conventionnel pour participer activement à l'évolution et rester au service des hommes.

Hadi Teherani, architecte et designer industriel.

C'est par la sensibilité que la forme appréhende l'essence du matériau et de la destination de l'objet ; par degrés, dégager le signifié profond pour saisir l'essentiel et s'ouvrir dans un contexte nouveau. La recherche a pour fin de masquer la technologie pointue pour atteindre les sphères éthérées de la perfection.

nl_Helmut, Werner en Joachim Link, eigenaren en directeurs van Interstuhl.

Het samenspel van onze studie en jarenlange ervaring komt in Silver ten volle tot uiting. Interstuhl is al bijna 50 jaar gespecialiseerd in de ontwikkeling van mensgerichte, fraai vormgegeven producten die een optimale zithouding stimuleren – een voortdurend zoeken naar het kwalitatieve meesterwerk. Is het ene voltooid, dan moet er een volgende komen. Innovatie ontstaat in bedrijven die een eigen beleid ontwikkelen en zich daar consequent aan houden. Ons bedrijf moet vrij blijven van conventies, om in zijn vitale ontwikkeling de mens te kunnen blijven dienen.

Hadi Teherani, architect en productontwerper.

De vormgeving moet het wezenlijke van de materiaalkeuze en de functies emotioneel uitstralen. Stap voor stap moet eerst de kern van de betekenis worden blootgelegd, om de essentie te vatten. Vervolgens wordt hier een nieuwe context voor gevonden. Het doel was gesteld om de technische complexiteit van Silver onzichtbaar te maken en het poëtische niveau van perfect zitten te bereiken. Een stoel die alleen op kantoor kan worden gebruikt, is te weinig. Esthetiek zonder ethiek is bedrog.

es_Helmut, Werner y Joachim Link, propietarios y gerentes de Interstuhl.

La combinación de nuestros estudios y de los conocimientos basados en años de experiencia se reflejan en Silver. Desde hace casi 50 años, Interstuhl está especializada en el desarrollo de objetos ergonómicos y estéticos que permiten sentarse de forma beneficiosa, siempre en busca de la obra de arte cualitativa. Una vez terminada una pieza, siempre tiene que seguirle otra. La innovación se crea en empresas que aprecian y persiguen una política propia. Nuestra empresa debe permanecer libre de convenciones para estar siempre activamente al servicio del ser humano en su desarrollo.

Hadi Teherani, arquitecto y diseñador de productos.

La forma debe alcanzar emocionalmente la esencia del material y del uso, el núcleo del significado debe ponerse al descubierto capa por capa para captar lo esencial, y para encontrar un nuevo contexto. El objetivo consistió en hacer desaparecer la complejidad técnica de Silver y de alcanzar el nivel poético de sentarse perfectamente. Una silla que solo puede usarse en la oficina no es suficiente. La estética sin ética es un fraude.

it_Helmut, Werner e Joachim Link, proprietari e amministratori di Interstuhl.

La complementarità dei nostri studi e delle conoscenze pluriennali confluiscono in Silver. Da quasi 50 anni Interstuhl è specializzata nello sviluppo della redditizia seduta e di prodotti a misura di persona ed esteticamente belli, alla costante ricerca del capolavoro qualitativo. Completato uno, si passa al successivo. L'innovazione nasce all'interno di aziende che tengono alta e perseguono una propria politica. La nostra azienda deve rimanere libera dalle convenzioni affinché continui a evolversi con vivacità in funzione delle persone.

Hadi Teherani, architetto e designer del prodotto.

La forma deve raggiungere l'essenza del materiale e dell'utilità in modo emozionale; strato dopo strato deve innanzi tutto essere portato alla luce il valore vero e proprio, per cogliere l'essenziale e quindi per trovare un nuovo contesto. L'obiettivo era quello di rendere invisibile la complessità tecnica di Silver e di raggiungere il piano poetico della seduta perfetta. Una sedia da usare solo in ufficio è troppo poco. L'estetica senza l'etica è un'illusione.

Von Bildern und Vorbildern

Images and ideals

Présentation et représentation

Over vormgeving en voorbeelden

De imágenes y modelos

Immagini e modelli



Geborgenheit in Technik, Schalenkonzept, unsichtbare Funktion, futuristischer Barock
Security in technology, shell concept, hidden function, futuristic baroque
Technique conviviale, conception par coque, fonctionnalités invisibles, futurisme volubile
Geborgenheid in techniek, schaalconcept, onzichtbare functie, futuristische barok
Tecnica sicura, concezione della scocca, funzionamento invisibile, barocco futuristico



Stufen der Entwicklung
 Stages of the design process
 Etapes du développement
 Fasen in de ontwikkeling
 Niveles de desarrollo
 Fasi dello sviluppo

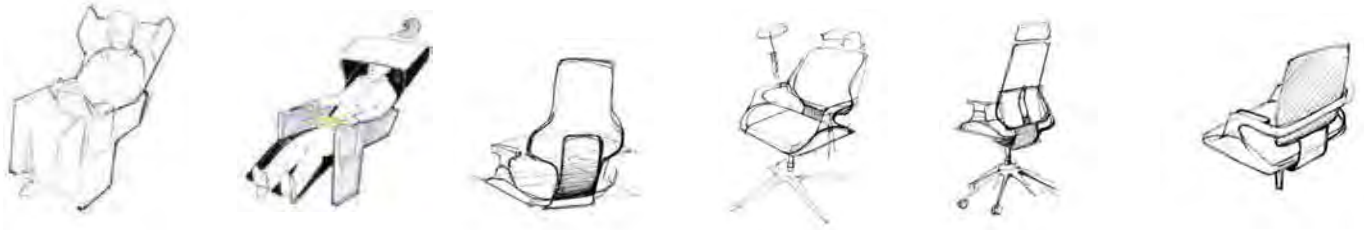

Ideas

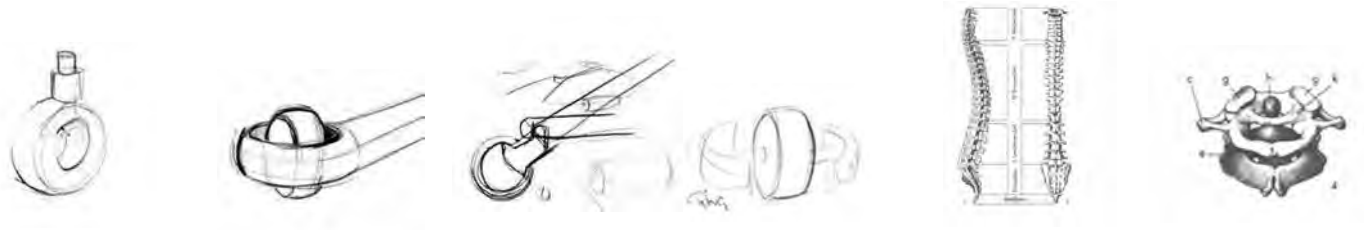

Details

Ergonomics

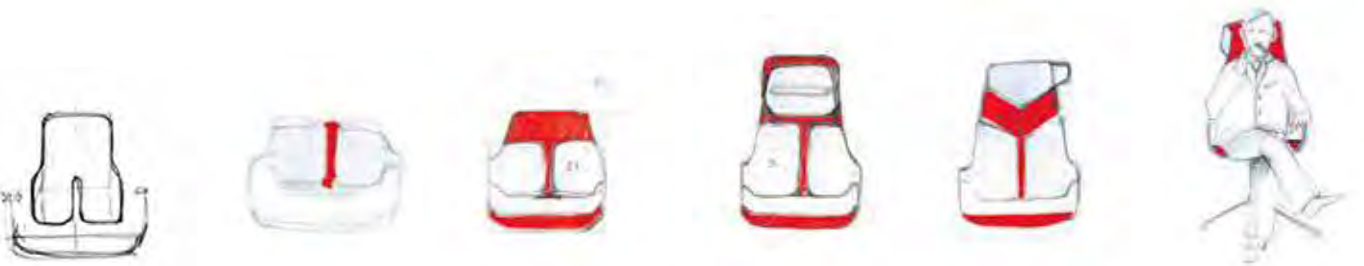

Variations



Family

Mechanics



Model



Silver





Bürodrehstühle

Office swivel chairs

Sièges de bureau pivotants

Kantoordraistoelen

Sillas giratorias de oficina

Sedie girevoli da ufficio



100S



162S



262S



362S

Die komplette Familie vom Hocker bis zum Drehsessel

The whole family, from stool to swivel chair

Du tabouret au siège pivotant, du petit au plus grand

De complete collectie, van hocker tot draaistoel

La familia al completo, del taburete a la silla giratoria

L'intera famiglia, dallo sgabello alla sedia girevole

Bürodrehstühle

Office swivel chairs

Sièges de bureau pivotants

Kantoordraaistoelen

Sillas giratorias de oficina

Sedie girevoli da ufficio



362S



100S

Das ideale Paar: Drehsessel und Hocker

Made for each other: Swivel chair and stool

Fauteuil pivotant et tabouret bien assortis

Het ideale paar: draaifauteuil en hocker

La pareja ideal: sillón giratorio y taburetedonker Reiken

L'accoppiata ideale: poltrona girevole e sgabello



162S

Bürodrehstühle mit Synchronmechanik und Gewichtsregulierung

Office swivel chairs with synchronous mechanism and weight regulation

Sièges de bureau à système synchrone et réglage en fonction du poids de l'utilisateur

Kantoordraaistoelen met synchroontechniek en gewichtsregeling

Sillas giratorias de oficina con mecanismo sincrónico y regulación de peso

Sedie da ufficio girevoli con meccanismo sincronizzato e regolazione del peso

Konferenzsessel

Conference chair

Fauteuils de conférence

Conferentiefauteuils

Sillones de conferencia

Poltrona per conferenza



191S

Drei Aluminiumoberflächen: beschichtet weiß, silber gestrahlt, silber gebürstet

Three aluminium finishes: coated white, sandblasted silver, brushed silver

Trois surfaces aluminium : à revêtement blanc, sablé argent, brossé argent

Aluminium oppervlakken in drie uitvoeringen: wit-zilver gelakt, gestraald, geborsteld

Tres superficies de aluminio: con recubrimiento blanco, plateada pulida con chorro de arena, plateada cepillada

Tre superfici in alluminio: laminata bianca, sabbiata argento, spazzolata argento



Große Vielfalt in Leder und Stoffen

Wide variety of leathers and fabrics to choose from

Grand choix de cuirs et de tissus

Grote verscheidenheid aan stoffen en leer

Gran variedad en piel y tela

Ampia varietà di pellami e tessuti

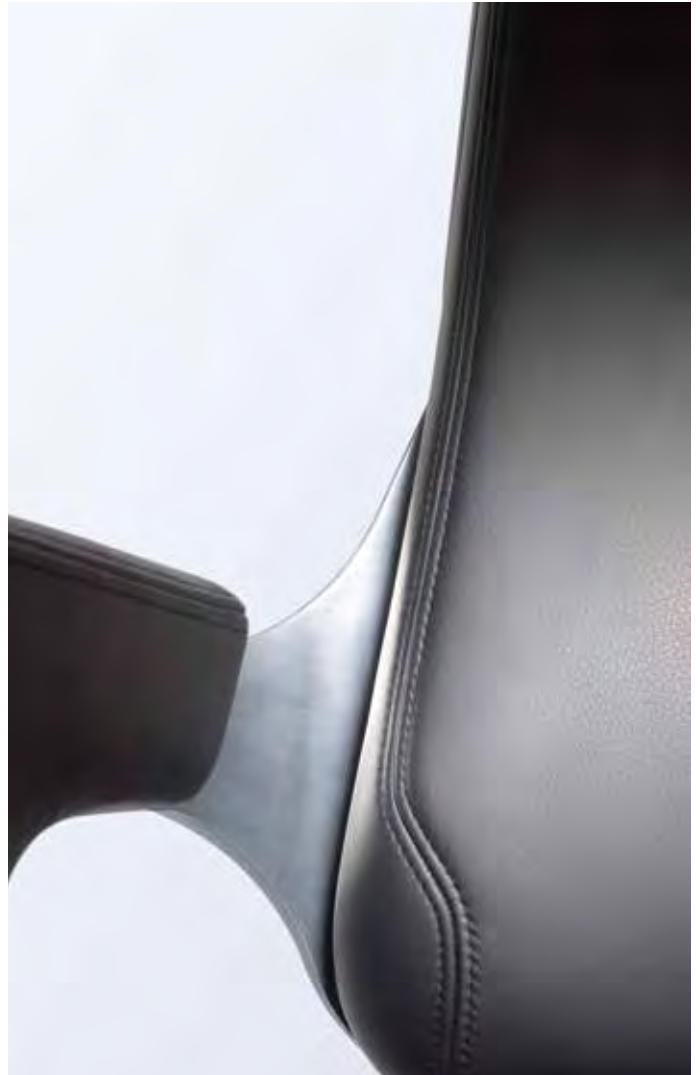

Innovation und handwerkliche Perfektion
Innovation and craftsmanship
Innovation et perfection artisanale
Innovatie en ambachtelijke perfectie
Innovación y perfección artesanal
Innovazione e perfezione artigianali





d_Die Technik fügt sich in das Gesamtbild des Stuhles ein. Alle Bedienelemente bieten intuitive Nutzerführung für die Funktionen. Rückenlehnenarretierung und Sitzhöhenverstellung befinden sich in den Griffmulden, die in der Schale perfekt eingearbeitet sind.

gb_Technology is an integral component of the overall chair design. All controls offer intuitive user guidance for function execution. The backrest lock and seat height adjustment mechanisms are located in recessed grips which merge seamlessly with the chair's shell.

fr_La technologie est intégrée aux lignes du siège. Les mécanismes de réglage se distinguent par la convivialité intuitive du fonctionnement. Le blocage du dossier et le réglage de hauteur de l'assise se trouvent dans la cuvette de poignée, parfaitement incorporée dans la coque.

nl_De techniek past harmonisch in het totaalbeeld van de stoel. Alle bedienings-elementen maken het gebruik van de verschillende functies eenvoudig en intuïtief. De vergrendeling van de rugleuning en de zithoogteverstelling bevinden zich in de handgrepen, die perfect in de schaal van de zitting zijn verwerkt.

es_La técnica se integra en el aspecto global de la silla. Todos elementos de mando ofrecen al usuario una guía intuitiva para realizar las funciones. El bloqueo del respaldo y el ajuste de altura del asiento se encuentran en las empuñaduras empotradas, perfectamente integradas en el asiento.

it_La tecnica si fonde nell'immagine complessiva della sedia. Tutti gli elementi di comando permettono un azionamento intuitivo delle funzioni da parte dell'utente. Il bloccaggio dello schienale e la regolazione in altezza del sedile si trovano negli incavi delle maniglie perfettamente incorporate nella scocca.

d_Die Synchronmechanik vereint die Rückwärtsbewegung der Rückenlehne mit abgestimmter Neigung der Sitzfläche. So ist in jeder Position der Körper ideal abgestützt.

gb_The synchronous mechanism combines the backwards motion of the backrest with the balanced inclination of the seat, thereby providing optimum support for the body in any position.

fr_Le système synchrone coordonne le basculement du dossier vers l'arrière en corrélation avec l'inclinaison de l'assise. Quelque soit la position du corps, son maintien est assuré à la perfection.

nl_De synchroontechniek combineert een achterwaartse beweging van de rugleuning met een aangepaste neiging van het zitvlak. Op die manier wordt het lichaam in elke positie optimaal ondersteund.

es_El mecanismo sincrónico coordina el movimiento de retroceso del respaldo con una inclinación adaptada del asiento. Así, el cuerpo queda perfectamente apoyado en cualquier posición.

it_Il meccanismo sincronizzato combina il movimento all'indietro dello schienale con un'adeguata inclinazione della superficie del sedile. In tal modo il corpo è sostenuto in modo ottimale in qualsiasi posizione.

d_Das Einstellrad an der Sitzunterseite hat eine ausklappbarer Kurbel zur Gewichtsregulierung der Synchronmechanik, die eine genaue Abstimmung der Funktion auf das Körpergewicht des Nutzers erlaubt.

gb_The setting wheel on the underside of the seat has a fold-out crank for weight regulation of the synchronous mechanism, allowing the chair's function to be matched specifically to its user's body weight.

fr_La molette de réglage dans la partie inférieure du siège, munie d'une manivelle rabattable, permet le réglage en fonction du poids par système synchrone, d'où un réglage précis du fonctionnement adapté au poids de l'utilisateur.

nl_De verstelhendel onder de zitting is uitklapbaar voor de eenvoudige verstelling van de gewichtsregeling, die exact op het lichaamsgewicht van de gebruiker kan worden afgestemd.

es_La rueda de ajuste en la parte inferior del asiento dispone de una manivela desplegable para la regulación de peso del mecanismo sincrónico, que permite adaptar la función exactamente al peso del usuario.

it_La rotella di regolazione presente sul lato inferiore del sedile è dotata di una manovella ribaltabile per la regolazione del peso e del meccanismo sincronizzato permettendo di adattare perfettamente il funzionamento al peso dell'utilizzatore.



d_Technik die begeistert.

gb_Technology to get excited about.

fr_Une technique qui vous transporte.

nl_Techniek die fascineert.

es_Técnica inspiradora.

it_Tecnica che entusiasma.

d_Die Loungemodelle verfügen über eine Rückholmechanik. Nach Benutzung werden die Sessel automatisch in ihre Ursprungsp-position zurückgeführt, und geben so ein einheitliches Bild im Raum.

gb_The Lounge model features an auto-return mechanism. When the person who has been sitting on the chair gets up, it will return to its original position, thereby harmonising the overall visual impression of the interior space.

fr_Les modèles Lounge disposent d'un système à force de rappel. Après utilisation, les sièges reviennent automatiquement à leur position de départ et les salles paraissent bien rangées.

nl_De loungemodellen zijn voorzien van een terugdraaimechaniek. Na gebruik komen de fauteuils automatisch in hun oorspronkelijke stand terug, zodat in de ruimte altijd een uniform beeld heerst.

es_Los modelos Lounge disponen de un sistema mecánico de recuperación. Después de utilizarlos, los sillones regresan automáticamente a su posición original, ofreciendo así una imagen espacial uniforme.

it_I modelli lounge sono dotati di un meccanismo di richiamo. Dopo l'utilizzo le poltrone vengono riportate automaticamente nella loro posizione iniziale creando nell'ambiente un'immagine uniforme.





Loungesessel und -tische. Bodenplatten-Inlays variabel gestaltbar

Lounge chairs and tables. Base plate inlays can be provided in various designs

Fauteuils et tables Lounge. Inserts de pieds à options multiples

Loungefauteuils en -tafels. De inleg voor de bodemplaat kan variabel worden vormgegeven

Sillones y mesas Lounge. Insertos de placa base de diseño variable

Poltrone e tavoli lounge. Inserti delle piastre di base configurabili in modo variabile



Tische / Konferenzpult / Sideboard

Table / conference desk / sideboard

Table / Pupitre de conférence / Meuble bas

Tafels / Lessenaar / Sideboard

Mesas / atriles de conferencia / sideboard

Tavoli / leggio per conferenza / tavolo di servizio



Vom Chefarbeitsplatz bis zum Konferenztisch, in Glas oder in unterschiedlichen Hölzern

From boss's desk to conference table, in glass or wood veneer

De la place de travail du directeur à la table de conférence, en verre ou en bois contreplaqués variés

Van het directiebureau tot en met de conferentietafel, in glas of in verschillende soorten houtfineer

Desde el despacho principal hasta la mesa de conferencia, en vidrio o con diferentes chapados en madera

Dalla postazione di lavoro dirigenziale al tavolo per conferenza, in vetro o in varie impiallaccature di legno



Konferenzpult, höhenverstellbar
Conference desk, height-adjustable
Pupitre de conférence à hauteur variable
Lessenaar, in hoogte verstelbaar
Atril de conferencia, regulable en altura
Leggio per conferenza, regolabile in altezza



866S

Sideboard
Sideboard
Meuble bas
Sideboard
Sideboard
Tavolo di servizio





Hochwertigste Materialien, Minerale Cocon und Ledereinlage
High-quality materials, Minerale Cocon and leather lining
Matériaux de haute qualité, Minerale Cocon et cuir incrusté
Hoogwaardige materialen, Minerale Cocon en inleg in leder
Materiales de primera calidad, Minerale Cocon e inserto de piel
Pregiati materiali, Minerale Cocon e inserti in pelle



Cheftisch, Bürodrehsessel, Besucherstühle, Rollcontainer

Manager's table, office swivel executive chair, visitor's chairs, mobile file unit

Table de Manager, siège de direction pivotant, chaises visiteur, unité de fichier mobile, caisson mobile

Directietafel, bureaudraaifauteuils, bezoekersstoelen, rolcontainer

Mesa de dirección, sillones giratorios de oficina, sillas de visitas, cajoneras con ruedas

Tavolo dirigenziale, sedie girevoli per ufficio, sedie per ospiti, cassetiera con rotelle









Rollcontainer als Sitzgelegenheit

Mobile file unit as seat
Caisson mobile utilisé comme siège
Rolcontainer als zitgelegenheid
Cajonera con ruedas como posible asiento
Cassetiera con rotelle con possibilità di seduta

Individuelle Datenanschlüsse für Chef- und Konferenztisch

Individual data connections for manager's and conference table
Connexions informatiques individuelles pour management et table de conférence.
Individuele data-aansluitingen voor directie- en conferentietafels
Conexiones individuales de datos para mesa de dirección y de conferencia
Attacchi collegamento dati individuali per tavolo dirigenziale e tavolo per conferenze

Flächenbündig integrierte Konferenz- und Medientechnik

Flush-mounted conference and media technology
Technologie multimédia
Geïntegreerde conferentie- en mediatechniek
Paquete de conferencia y comunicación de datos integrado al ras
Tecnologia conferenziale e multimediale integrata a paro



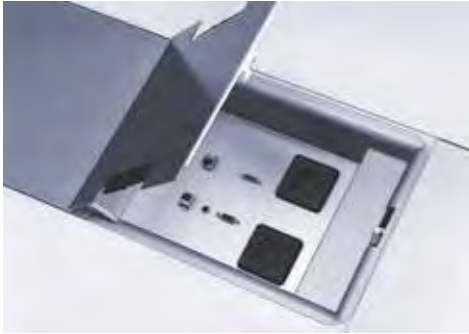

d_Perfekte Organisation für alle Datenanschlüsse Workstation, 2 Laptops, Multimedia und Bedieneinheit für Peripherie-Audiogeräte, flächenbündig in den Konferenztisch eingebaut. 1 x VGA, 1 x Audio, 2 x LAN (RJ45), 1 x HDMI, 2 x 230 V „Look at me-Funktion“.

gb_Perfect organisation for all data connections workstation, 2 laptops, multimedia and control unit for peripheral audio equipment, flush mounted in the conference table. 1 x VGA, 1 x Audio, 2 x LAN (RJ45), 1 x HDMI, 2 x 230 V „Look at me - Function“.

fr_Organisation parfaite pour toutes les connexions informatiques, 2 ordinateurs portables, équipement multimédia et unité de commande pour équipement audio périphérique, flux monté dans la table de conférence. 1 x VGA, 1 x Audio, 2 x LAN (RJ45), 1 x HDMI, 2 x 230 V „Look at me - fonction“.

nl_Perfekte organisatie voor alle data-aansluitingen "Werkstation", 2 laptops, multimedia en bediening voor omringende audio apparatuur, in de vergadertafel ingebouwd. 1 x VGA, 1 x audio, 2 x LAN (RJ45), 1 x HDMI, 2 x 230 V, incl. data aansluitmanager

es_Perfecta organización para todas las conexiones de datos de estaciones de trabajo, 2 portátiles, multimedia y cuadro de mandos para dispositivos de audio periféricos, todas incorporadas al ras en la mesa de conferencia. 1 x VGA, 1 x audio, 2 x LAN (RJ45), 1 x HDMI, 2 x 230 V „Look at me - función“

it_Perfetta organizzazione per tutti gli attacchi collegamento dati, workstation, 2 laptop, attrezzatura multimediale e unità di comando per apparecchiature audio periferiche, incassata a paro nel tavolo per conferenze. 1 x VGA, 1 x audio, 2 x LAN (RJ45), 1 x HDMI, 2 x 230 V „look at me - funzione“.

d_Die vertikalen Kabelableitungen sorgen für ein sauberes Erscheinungsbild. Formschön und reduziert im Produktdesign integrieren sie sich formal in die Serie.

gb_The vertical cable trays make for a tidy appearance. Their elegant and reduced product design is easily integrated in the series form.

fr_Les passe câbles donnent une apparence rangée et s'intègre parfaitement avec élégance.

nl_De verticale kabelgeleiders zorgen voor een strak uiterlijk. Fraai en minimalistisch qua productdesign integreren ze in de collectie.

es_Los canales verticales para cables proporcionan un aspecto ordenado. Se integran estéticamente en la serie con formas elegantes y compactas.

it_Le uscite in verticale dei cavi creano un quadro dall'aspetto lineare ed ordinato. Eleganti e dal design essenziale esse si integrano perfettamente nel linguaggio formale della serie.



d_Hubeinheit für Bildschirm bis 42"
für die Integration im Sideboard

gb_Screen lift for screen up to 42"
for the integration in the sideboard

fr_Unité de levage pour écran LED
jusqu'à 42" / 65" pour intégration
dans crédence

nl_Gemotoriseerde tv-lift voor LED
tv tot 42" voor toepassing in het
sideboard.

es_Soporte para pantalla LED de
hasta 42" para ser integrada en
la credenza.

it_Unità di sollevamento per schermi
fino a 42 pollici per l'integrazione in
sideboard.



d_Hubeinheit für Bildschirm bis 65"
für die Integration im Sideboard

gb_Screen lift for screen up to 65"
for the integration in the sideboard

fr_Unité de levage pour écran LED
jusqu'à 42" / 65" pour intégration
dans crédence

nl_Gemotoriseerde tv-lift voor LED
tv tot 65" voor toepassing in het
sideboard.

es_Soporte para pantalla LED de
hasta 65" para ser integrada en
la credenza.

it_Unità di sollevamento per schermi
fino a 65 pollici per l'integrazione in
sideboard.

Overview
 Aperçu
 Overzicht
 Vista general
 Panoramica

Bürodrehstühle / Drehsessel
 Office swivel chairs
 Sièges de bureau pivotants
 Kantoordraistoelen
 Sillas giratorias de oficina
 Sedie girevoli da ufficio

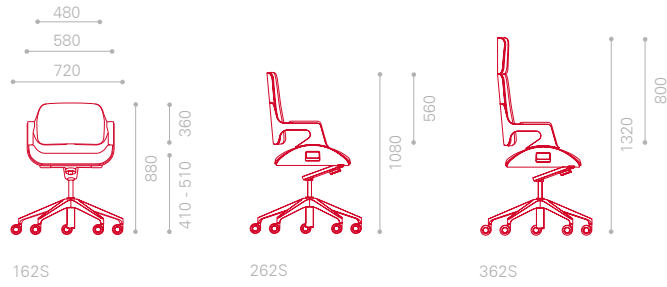

Lounge

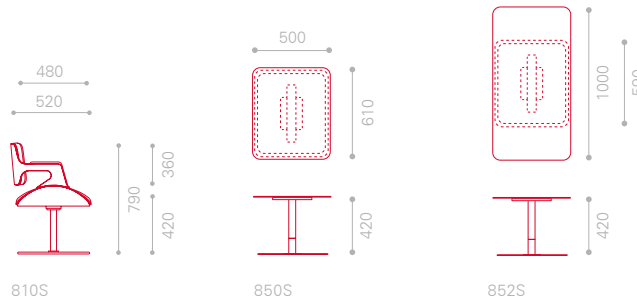

Konferenzpult
 Rollcontainer
 Sideboard

Conference lectern
 Mobile file unit
 Sideboard

Lutrin de conférence
 Caisson mobile
 Meuble bas

Conferentie kathedr
 Rolcontainer
 Sideboard

Atril de conferenția
 Cajonera con ruedas
 Credenza

Leggio per conferenza
 Cassetiera con rotelle
 Sideboard

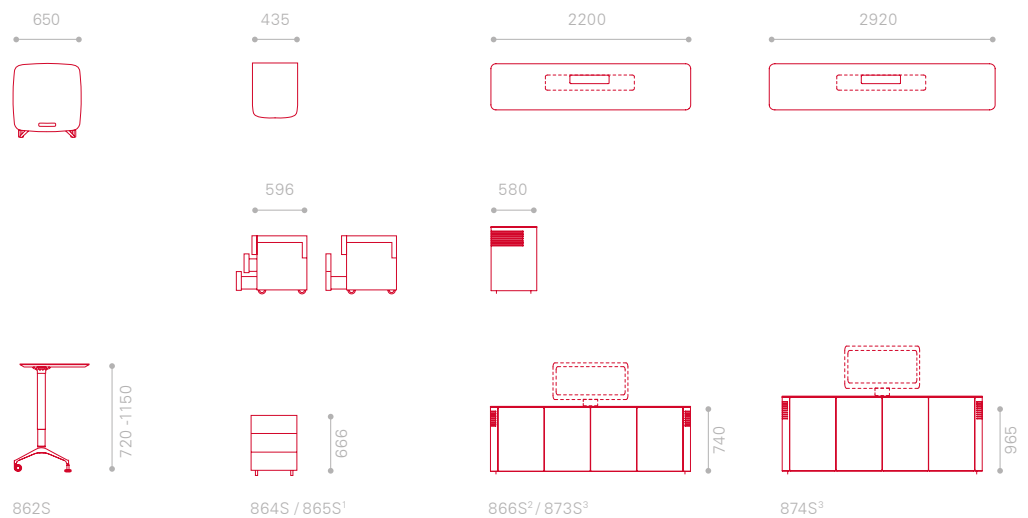

Konferenzstühle / Konferenzsessel

Conference chairs
Sièges de conférence
Conferentiestoelen
Sillas de conferencia
Sedie per conferenza

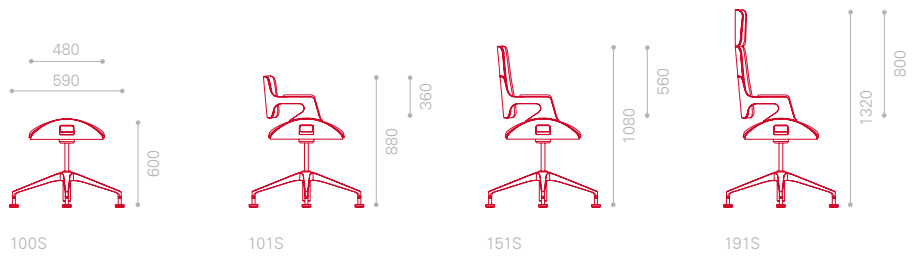

Tische

Tables
Tables
Tafels
Tavoli

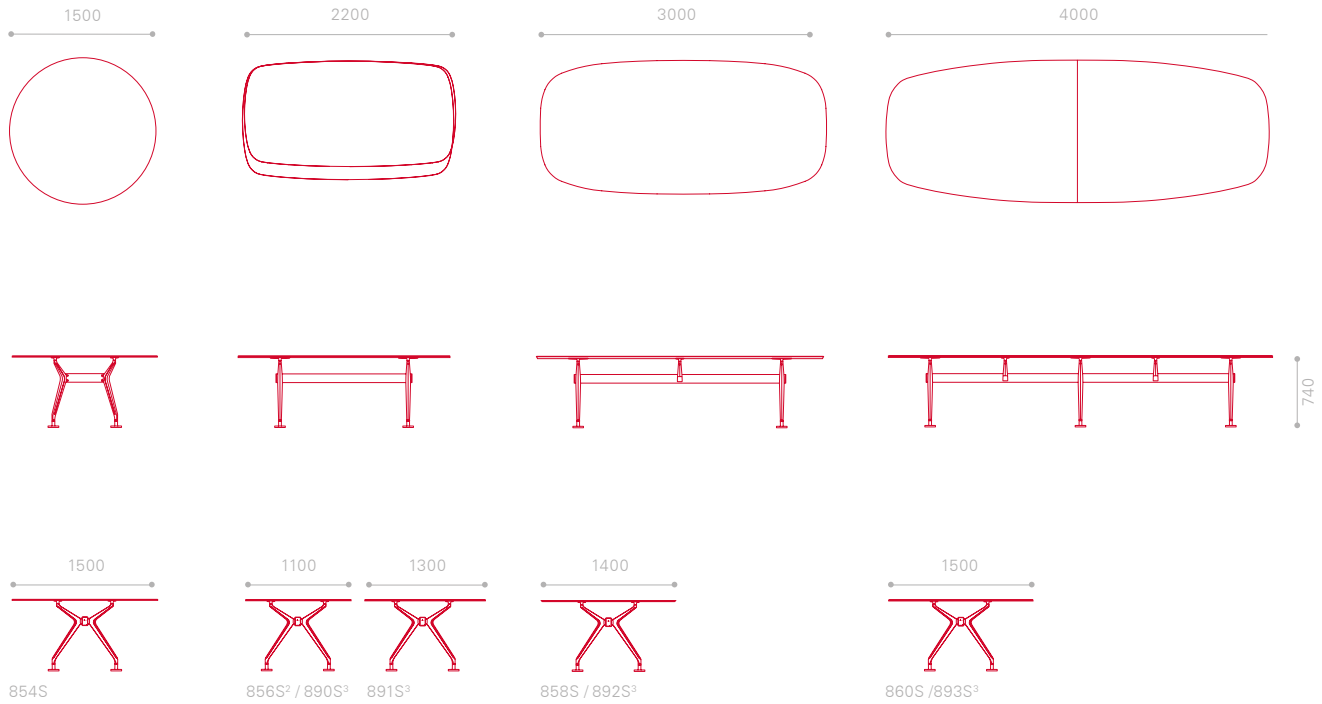

¹ mit zwei Ausziehschüben | with two telescopic drawers | avec deux tiroirs télescopiques | met twee lades | opcionalmente con dos bandejas extraíbles | con due estraibili
² optional mit Ledereinlagen und -auflagen | optionally with leather inlays and supports | avec insert en cuir en option | optioneel met leder inleg en -opdek
 opcionalmente con inserciones o revestimiento de piel | optional con inserti ed applicazioni in pelle
³ vorbereitet für die Integration Medientechnik | optionally with conference and media technology | technique multimedia en option | optioneel met vergader en multi-media
 techniek | opcionalmente con paquete de conferencia y comunicación de datos | optional con tecnologia per conferenza

d_interstuhl Manufactur erfüllt speziellste Bedürfnisse individueller Gestaltung und anspruchsvoller Kunden. Es ist die zielorientierte Beratung mit Designern und Architekten, und die Kreation von Unikaten und exklusive Einzelanfertigungen für Objekte. Alle Wünsche können in Serien unterschiedlichsten Umfangs umgesetzt werden.

gb_interstuhl Manufactur responds to the most specific needs in terms of individual design and customers who expect nothing but the best. The focus is on requirement-specific consulting involving designers and architects and on the creation of unique works of art for individuals and exclusive individual pieces. Every requirement can be responded to in the form of entire ranges of differing sizes

fr_ La manufacture interstuhl apporte la réponse aux exigences les plus pointues et assure aux clients les plus exigeants une conception et un design personnalisés. Le conseil orienté vers l'objectif donné par les designers et les architectes trouve son expression dans la création de pièces uniques et de fabrication individuelle en exclusivité. Toutes les demandes peuvent trouver leur réalisation dans des séries allant des plus petites aux plus grandes.

nl_interstuhl Manufactur vervult alle bijzondere behoeften op -het gebied van individuele vormgeving – speciaal voor de veeleisende klant. Hieronder verstaan wij een doelgericht overleg met ontwerpers en architecten en de creatie van unieke en zeer exclusieve designproducten op maat. Alle wensen kunnen in series van uiteenlopende omvang worden gerealiseerd.

es_ La manufactura interstuhl satisface los requerimientos más particulares en lo que a un diseño individual y clientes exigentes se refiere. Consiste en un asesoramiento específico con diseñadores y arquitectos, y en la creación de piezas únicas y exclusivas para objetos. Cualquier deseo puede realizarse en series de diferente volumen.

it_interstuhl Manufactur soddisfa le esigenze più particolari di una configurazione personalizzata e di clienti esigenti. Grazie alla consulenza mirata con designer e architetti e alla creazione di pezzi unici e singole realizzazioni esclusive per gli oggetti. Tutti i desideri possono essere realizzati in serie con le più diverse portate.

teak, Felt,
 Nubuk, Mogano, Oro,
 Radica, Wengé, Rame, Or,
 Ulivo, Broccato, Alcantara,
 Cedro, Argento, Kevlar, Acciaio,
 inossidabile, Principe di Galles,
 Lino, Velluto, Seta, Broccato, Fibra
 di carbonio, Nappa, Coccodrillo,
 Zebra, Mogano, Leopardo, Lino,
 cèdre, Burbury, Alpaca, Mohair,
 Zebrano, Teak, Feltro, Batista, Or,
 Platino, LimPelle scamosciata,
 Jaquard, alpaca, Taffetà, ceder,
 zilver, Gobelin, Techno, Stampa
 Flock, Crash, Paillette, Burlington,

Cedro, Laminato metallico, Ottone, Velluto a coste, Acero, Azobé, Ottone, Castagno, Redwood, teck, nubuck, acajou,
 or bois de racine, wengé, cuivre, olive, brocart, alcantara, cèdre, argent, kevlar, acier, inoxydable, prince de galles, lin,
 velours soie, brocart, fibre de carbone, nappa, crocodile, zèbre, acajou, léopard, burbury, Fibra de carbón, alpaca, Zebrano,
 Teca, mohair, zebrano, teck, Edelstahl, Glencheck, Leinen, feutre, batiste, platine, daim, jacquard, taffetas, tapisserie, Kupfer,
 techno, impression floqué, crash, paillettes, burlington, cèdre, métallisé, lamé, peluche, velours, côtelé, azobé laiton, châtaignier,
 sequoia, Seda, Teak, Nubuck, Mahogany, Gold, Burl wood, Wenge, Copper, Olive, Brocade, Alcantara, Cedar, Silver, Kevlar, Stainless
 steel, Prince-of-Wales check, Linen, Velvet, Silk, Brocade, Carbon fibre, Nappa, Crocodile, Zebra, Mahogany, Leopard, Burberry,

Alpaca, Teak, Felt, Nubuk, Mogano,
 Or, Ulivo, Broccato, Alcantara,
 Platinum, Suede, Jacquard, Taffeta,
 Crash, Sequined Burlington, Cedar,
 Azobe Brass, European chestnut,
 goud, wortelhout, wengé, koper,
 kevlar, roestvrij staal, prince-
 koolstofvezel, nappa, krokodil,
 mohair, zebrano, teak, vilt,
 techno, flockprint, crash,
 azobé, messing,
 Wengé,

Oro, Radica, Wengé, Oro, Rame,
 Mohair, Zebrano, Teak, Felt, Batiste,
 Tapestry, Techno, Flock print, Teak,
 Metallic, Lamé, Teddy, Cord, Maple,
 Redwood, teak, nubuck, mahonie,
 olijf, brokaat, alcantara, ceder, zilver,
 de-galles linnen, fluweel, zijde, brokaat,
 zebra, Olive, mahonie, leopard, burbury, alpaca,
 batist, Oro,platina, wildleer, jacquard, taf, gobelin,
 pailletten, burlington, ceder, metallic, lamé, corduroy, ahorn,
 kastanje, redwood, Teca, Nubuk, Caoba, Oro, Madera, de raiz,
 Cobre, Oliva, Brocado, Alcántara, Cedro, Plata, Kevlar, Acero, inoxidable,
 Glencheck, Lino, Terciopelo, Seda, Brocado, Fibra de carbón, Napa, Cocodrilo, Cebra,
 Caoba, roestvrij, Leopardo, Burbury, Alpaca, galles, lin, velours soie, brocart, fibre de carbone,
 nappa, crocodile, zèbre, acajou, léopard, burbury, Fibra de carbón, alpaca, Zebrano, Teca, mohair, zebrano, teck,
 Edelstahl, Glencheck, Leinen, feutre, batiste, platine, daim, jacquard, taffetas, tapisserie, Kupfer, techno, impression floqué,
 crash, paillettes, burlington, cèdre, métallisé, lamé, peluche, velours, côtelé, azobé laiton, châtaignier, sequoia, Seda, Teak, Nubuck,
 Mahogany, Gold, Burl wood, Wenge, Copper, Olive, Brocade, Alcantara, Cedar, Silver, Kevlar, Stainless steel, Prince-of-Wales check, Linen,
 Velvet, Silk, Brocade, Carbon fibre, Nappa, Crocodile, Zebra, Mahogany, Leopard, Burberry, Alpaca, Teak, Felt, Nubuk, Mogano, Oro, Radica, Wengé,
 Oro, Rame, Or, Ulivo, Broccato, Alcantara, Mohair, Zebrano, Teak, Felt, Batiste, Platinum, Suede, Jacquard, Taffeta, Tapestry, Techno, Flock print, Teak, Crash,
 Sequined Burlington, Cedar, Metallic, Lamé, Teddy, Cord, Maple, Azobe Brass, European chestnut, Redwood, teak, nubuck, mahonie, goud, wortelhout, wengé, koper,
 olijf, brokaat, alcantara, ceder, zilver, kevlar, roestvrij staal, prince-de-galles linnen, fluweel, zijde, brokaat, koolstofvezel, nappa, krokodil, zebra, mahonie, leopard, burbury,
 alpaca, mohair, zebrano, teak, vilt, batist, platina, or, wildleer, jacquard, taf, gobelin, techno, flockprint, crash, pailletten, burlington, ceder, metallic, lamé, corduroy, ahorn, azobé,
 messing, kastanje, redwood, Teca, Nubuk, Caoba, Oro, Madera, de raiz, Wengé, Cobre, Oliva, Brocado, Alcántara, Cedro, Plata, Kevlar, Acero, inoxidable, Glencheck, Lino, Terciopelo,

золото **金** ذهب χρυσάφι **ゴールド** **goud** **броккат** **錦** بروكار **μπροκάρ** **錦織** brokaat **ТИК** **柚木** (تیک) ساج **teak** **チーク** kiaat
шелк **丝绸** حرير μετάξι **シルク** sy **шнур** **灯芯绒** قيطان **котλέ** コーデュロイ **koord** **нержавеющая сталь** **不锈钢** فولاذ لا يصدأ
ανοξειδωτος χάλυβας **ステンレススチール** vlekvrue **staal** **красное дерево** **桃花芯木** ماهوغاني **μαχόγκανι** **マホガニー** mahonie **леопард**
豹纹 نمr **λεοπάρδαλη** ヒョウ柄 **luiperd** **бурбури** **巴宝莉** **بيربيري** burbury /バーバリー burbury **альпака** **羊驼毛** ألباكا

Alpaca, Teak, Felt, Nubuk, Mogano, Oro, Radica, Wengé, Oro, Rame, Or, Ulivo, Broccato, Alcantara, Mohair, Zebrano, Teak, Felt, Batiste, Platinum, Suede, Jacquard,
 Taffeta,
 Tapestry,
 Techno,
 Flockprint,
 Teak, Crash,
 Sequined
 Cobre, Lino,
 Oliva, Plata,
 Brocado, Or,
 Alcántara,
 Teca, Acero,
 Plata, Crash,
 Kevlar, Ante,
 Acero, Fibra
 de carbón inoxidable,
 Glencheck, Lino, Seda,
 Terciopelo, Brocado,
 Fibra de carbón, Ante,
 Napa, Cocodrilo,
 Pana, Cebra, Caoba,
 roestvrij, Leopardo,
 Burbury, Alpaca, Or,
 Mohair, Zebrano, Teca,
 Fieltro, Or, Batista,
 Platino, Ante, Jacquard,
 Tafetán, Gobelino,
 Tecno, Flockprint, Or,
 Crash, Lentejuelas,
 Burlington, Cedro,
 Metálico, Lamé, Oro,
 Teddy, Pana, Nubuk
 ,Arce, Azobé, Lamé,
 Latón, Castaño, ,Arce,
 Secuoya, Teak, Lino,
 Nubuk, Mahagoni,
 teck, Gold, Wurzelholz,

αλπακάς **アルパカ** alpaka **мохер** **马海毛** موهر **μοχέρ** **モヘア** sybokhaar **зебрано** **斑马纹** مزرد
 zebrano **ゼブラ** zebrano **твид** **粗花呢** **تويد** tweed **ツイード** tweed **фетр** **毡** لاد **τσόχα** **フェルト** felt **серебро**
银 فضة **ασήμι** **シルバー** silver **углеродное волокно** **竹碳棉** ألياف كربون **ανθρακόνημα** **カーボンファイバー** koolstofvesel
батист **麻纱** باتيستة **batist** **バチスト** **batis** **платина** **白金** πλατιν **プラチナ** platinum **פלین** **府绸**
 Kupfer, techno, impression floqué, crash, paillettes, burlington, cèdre **بولين** **ποπλίνα** **ポプリン** popelien laiton, châtaignier, sequoia, Seda, Cord, Maple, Azobe Brass, European
 chestnut, Redwood, teak, nubuck, mahonie, goud, wortelhout, wengé, koper, olijf, brokaat, alcantara, ceder, zilver, kevlar, roestvrij Mahogany, Gold, Burl wood, Wenge, Copper, Olive, Brocade,

**AIT Innovations-
preis 2004**

best
selection office
design 2003



Nominierung zum
Designpreis
der Bundesrepublik
Deutschland
2006 & 2008



design award
2005



Designpreis
Baden-Württemberg



reddot design award
2003 & 2007



Neocon 2005



Neocon 2007

gold medal
BIURO 2007
Poznan







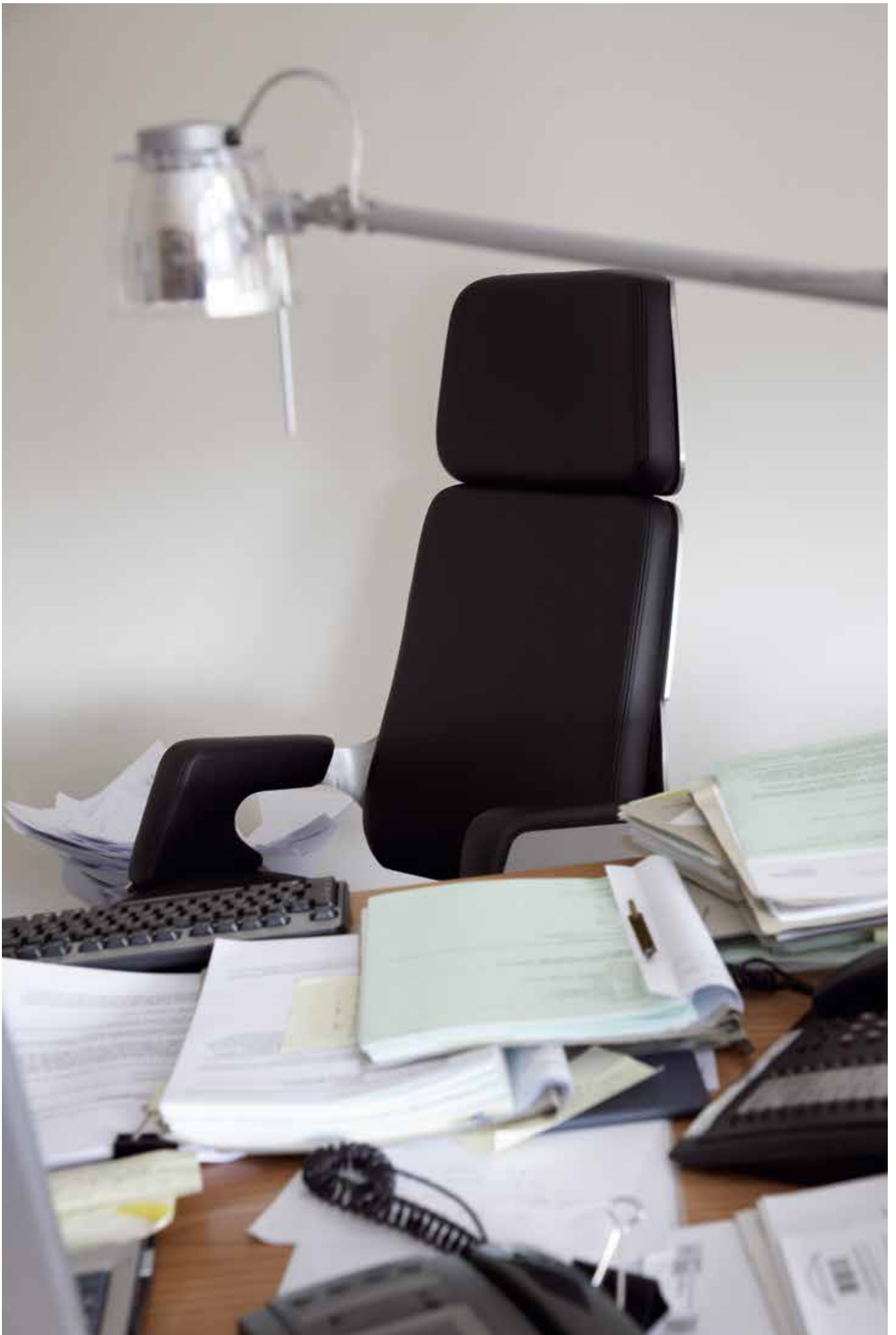





Chopin once said, if people would turn their thoughts into music, the world would be filled with wonderful peace and a lot of deaf people.



„Best book“ and “Worst book“ can only be defined by people, who read only 10. Or 10.000.













/ QUIET



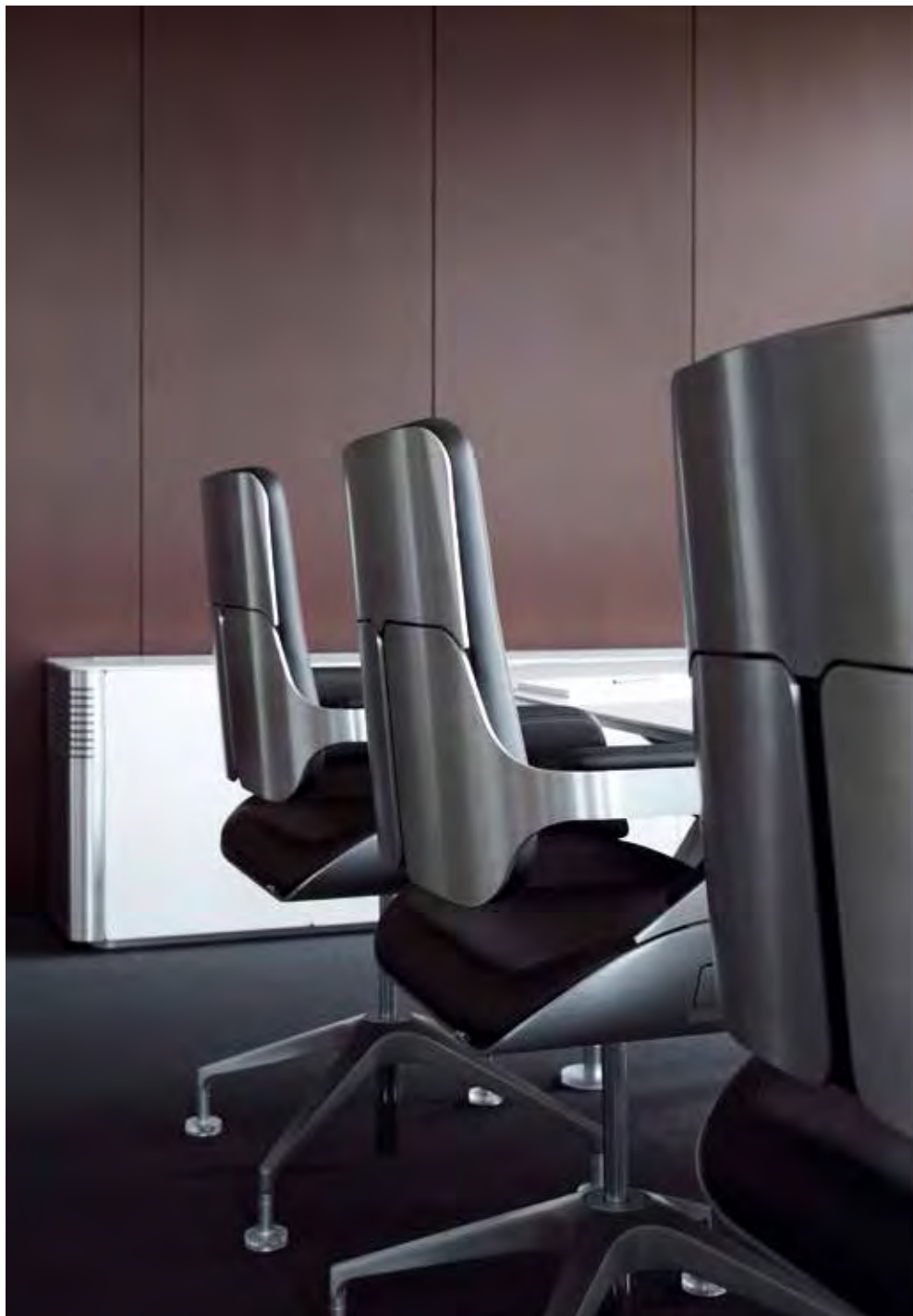

We are born lighting fires and die fighting them.





The higher the chair,
the thinner the air.









Elephant races are attempts of trucks, to overtake each other with marginal speed difference. On highways as well as in offices.











eat
and
drink.
live
and
work.
work
and
live.
live.













