

# Stehhilfen

9451

9454

9452

9456

9454E

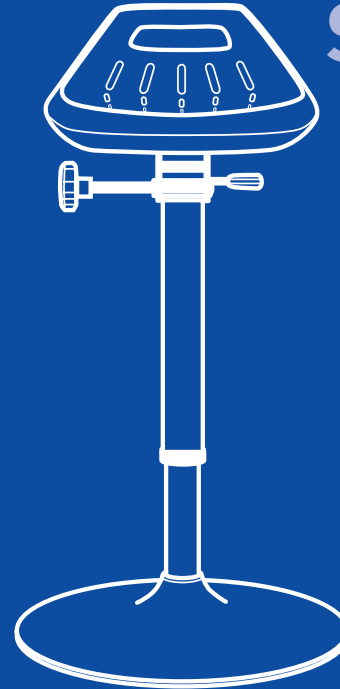

**bimos** – eine Marke der

Interstuhl Büromöbel GmbH & Co. KG  
Brühlstraße 21  
D 72469 Meßstetten-Tieringen  
Telefon: 0 74 36-8 71-0  
Telefax: 0 74 36-8 71-3 59  
info@bimos.de  
www.bimos.de

Ident.-Nr. 00032385

[www.bimos.de](http://www.bimos.de)

Montage- und Bedienungsanleitung  
Assembly and operating instructions

**bimos**



**A**

S. 4-9



**E**

S. 20



**B**



S. 10-13



**F**

S. 21



**C**



S. 14-17



**D**



S. 18-19

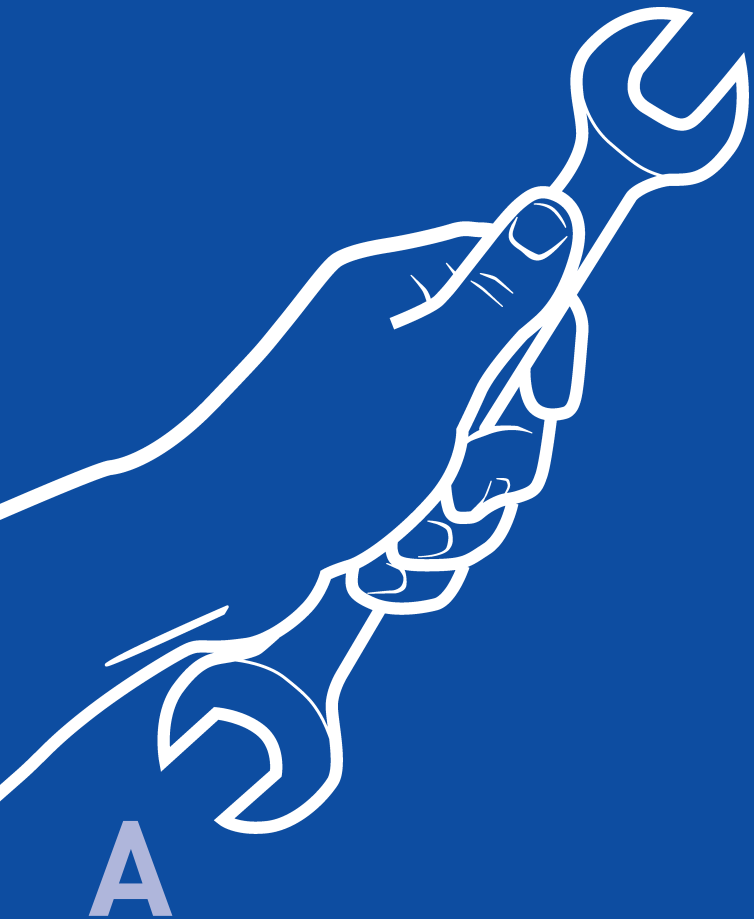

Typ 9454

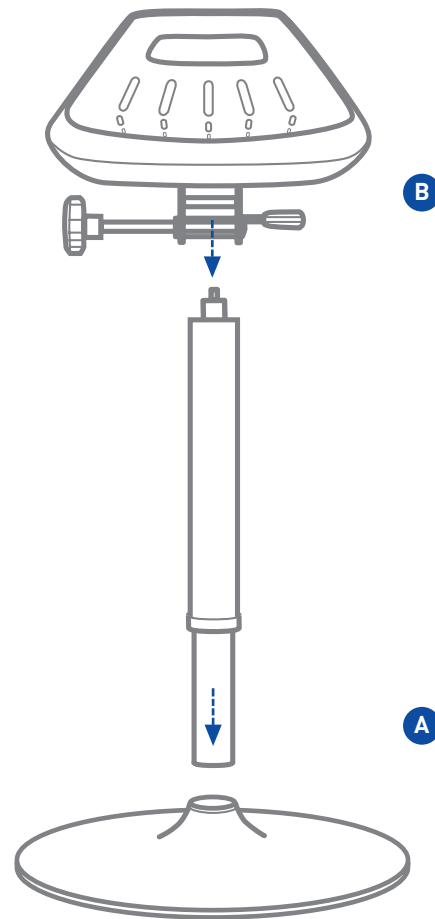

Typ 9451

Typ 9451

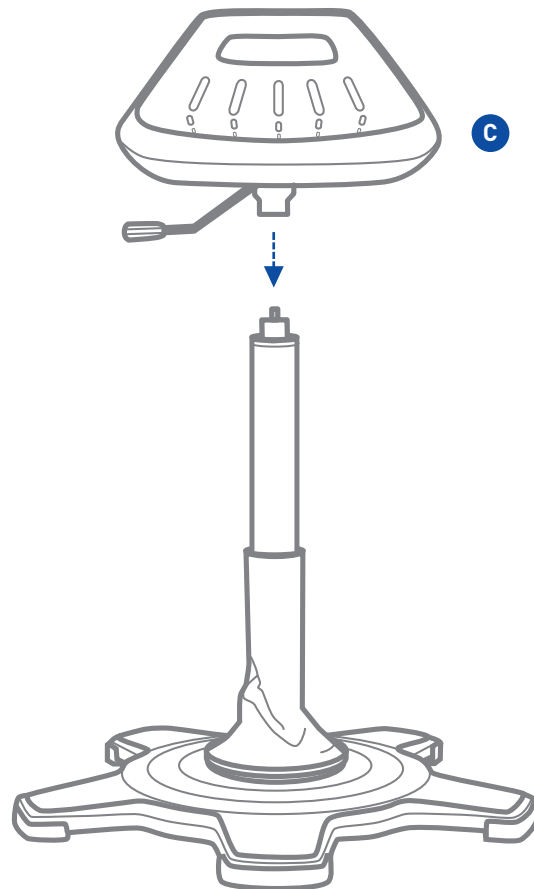
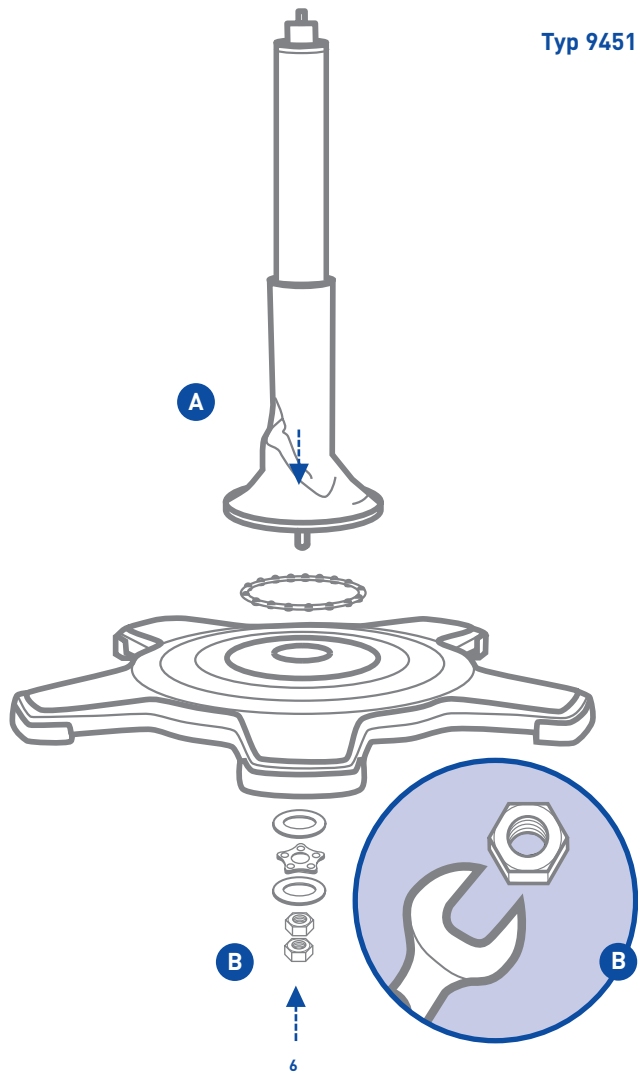

Typ 9452

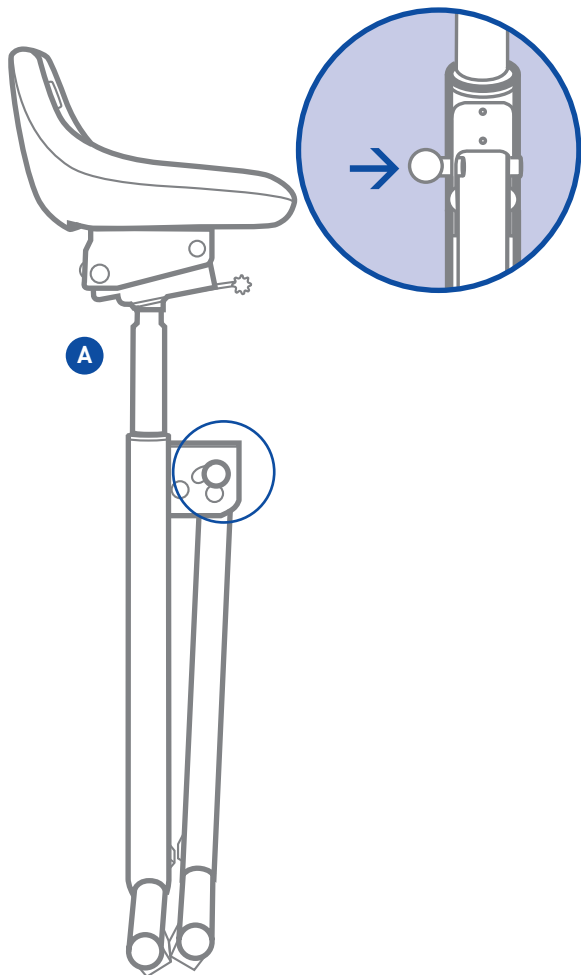

Typ 9452

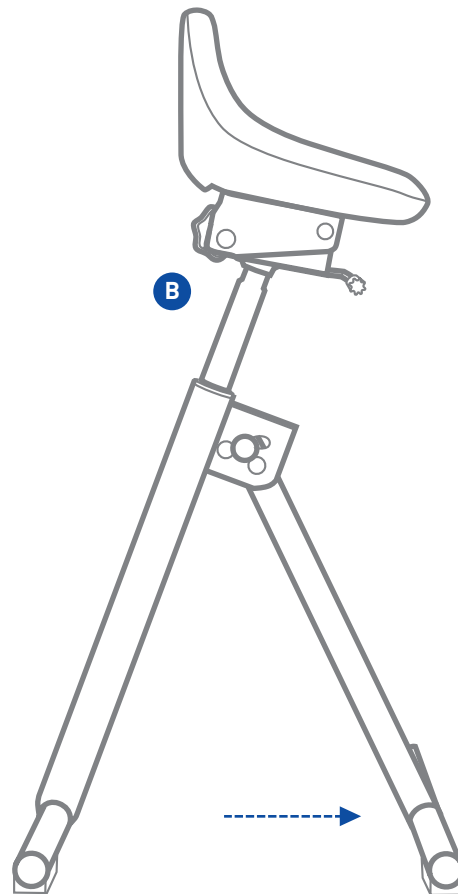

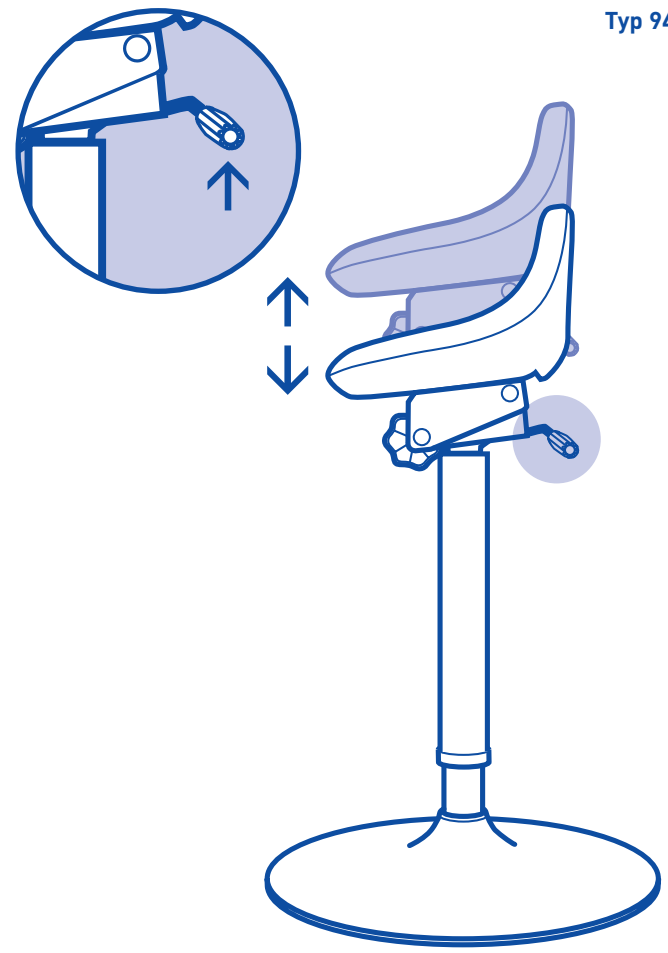
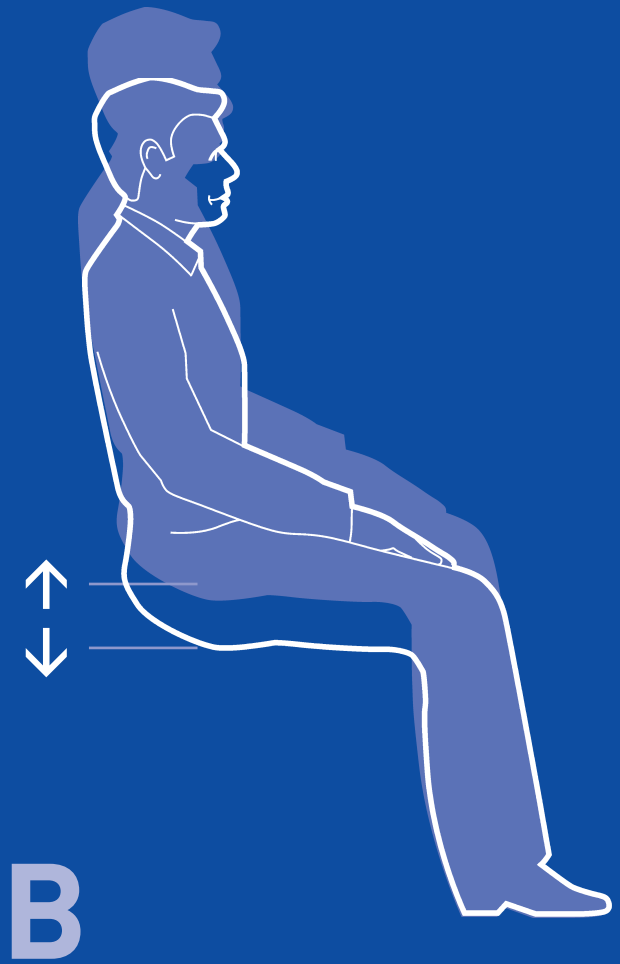

Typ 9451

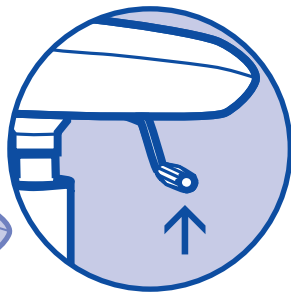
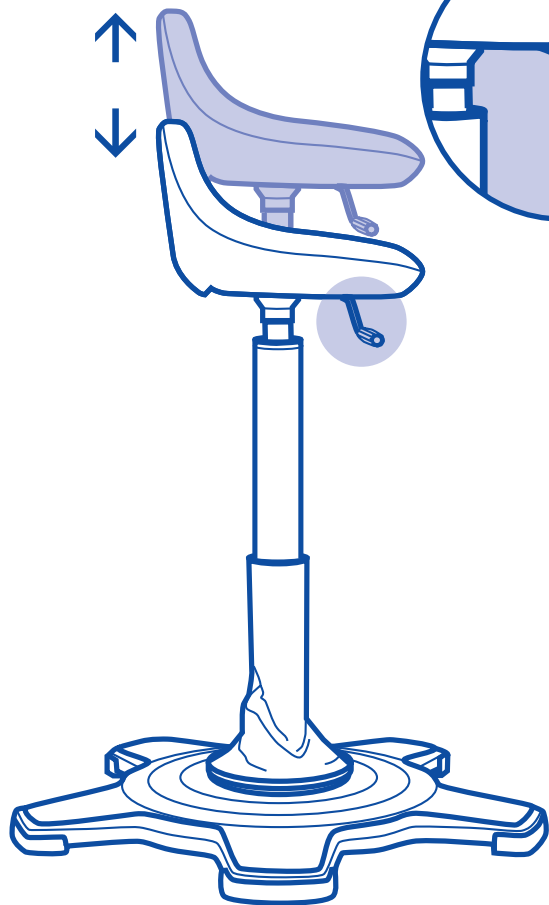

Typ 9452

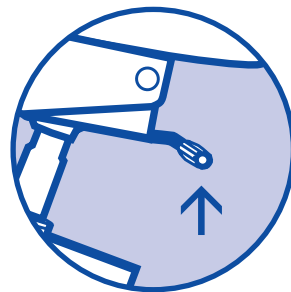
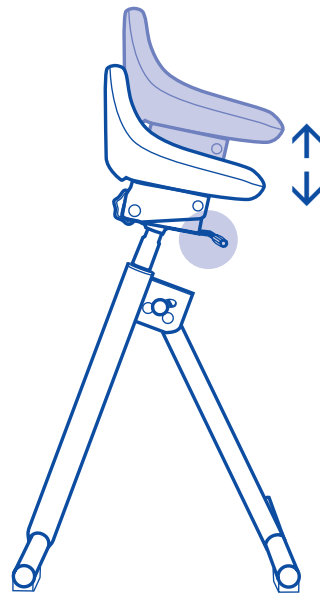

Typ 9456

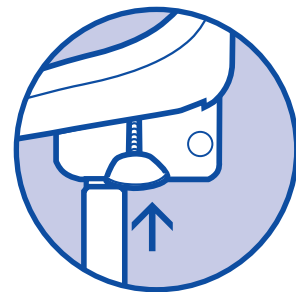
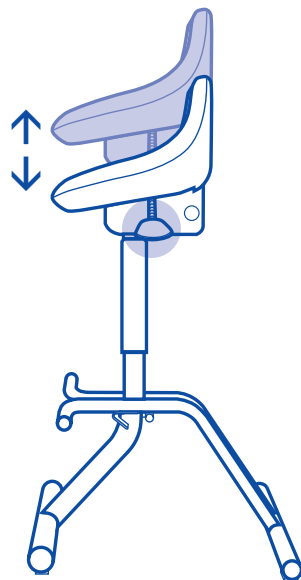

Typ 9454

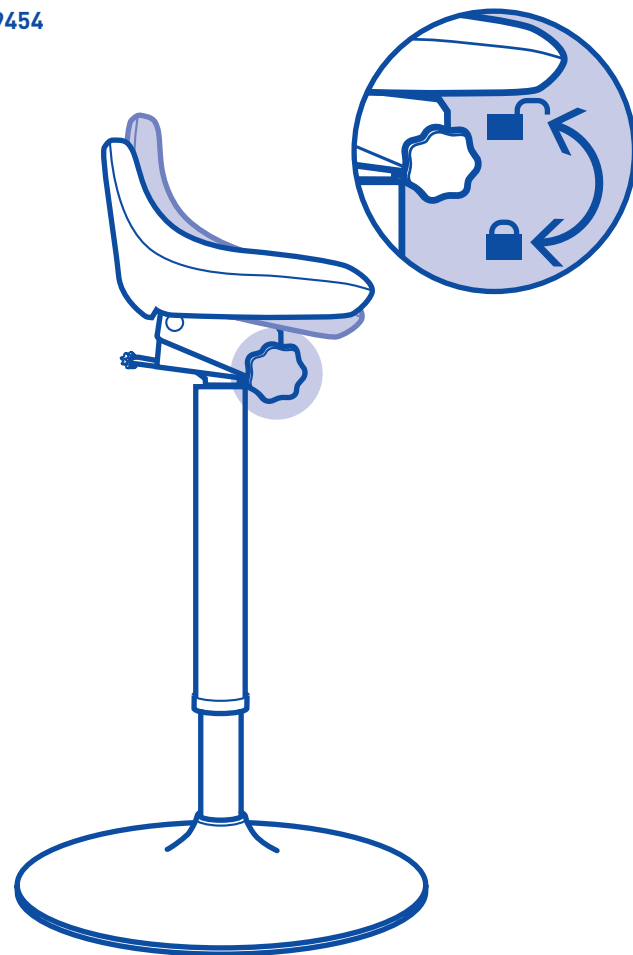

C

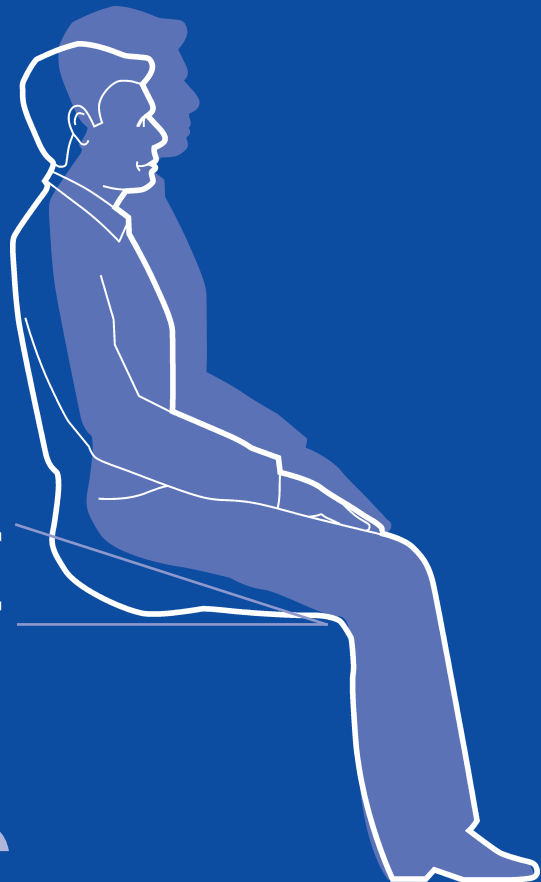



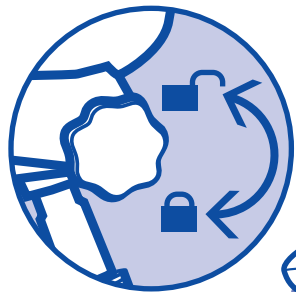

Typ 9452

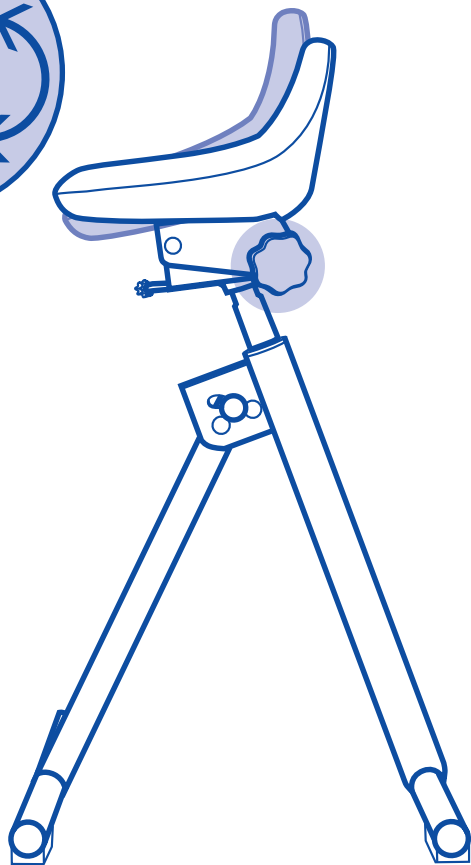

Typ 9456

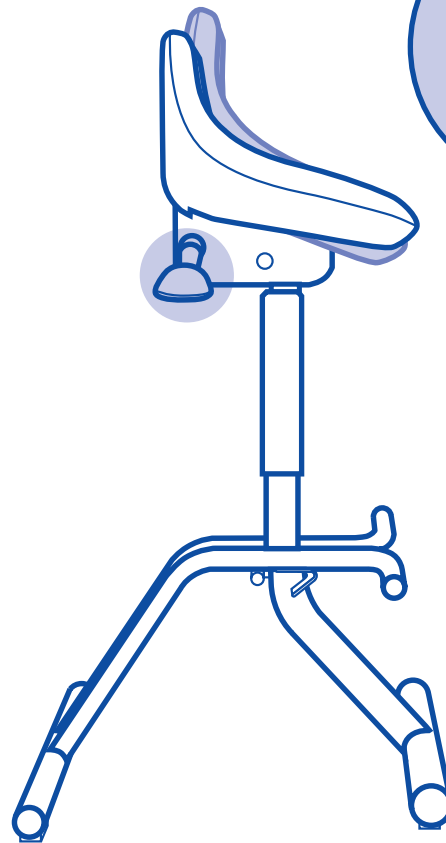
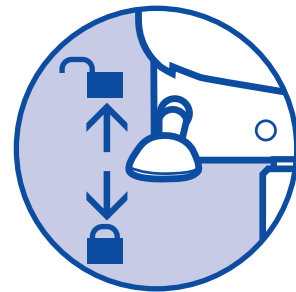

Typ 9451

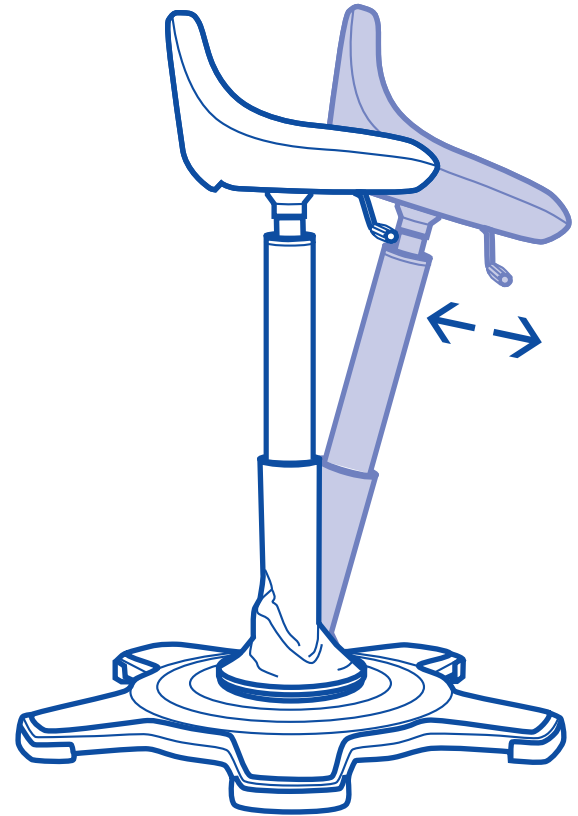

D



E



F



[www.bimos.de/cleaning.html](http://www.bimos.de/cleaning.html)

DIN  
68877



Garantie  
**5**  
Jahre



**bimos Produktion**



**bimos ESD**



**bimos Labor**



**bimos Reinraum**

# A passion for chairs



[www.interstuhl.de](http://www.interstuhl.de)



[www.bimos.de](http://www.bimos.de)



[www.prosedia.de](http://www.prosedia.de)