

# SNOWSOUND

Acoustics & wellbeing technologies

Caimi

# CAIMI BREVETTI

Made in Italy since 1949

**I** Fondata nel 1949, Caimi è una delle principali realtà produttive europee design oriented nel settore dell'arredamento, dei complementi d'arredo e delle soluzioni acustiche per l'ufficio, la casa e il contract. Da **oltre 70 anni** Caimi continua a ricercare e sperimentare nuove soluzioni per migliorare concretamente la vita delle persone e gli ambienti in cui vivono. Presente nei musei di design internazionali, Caimi ha ricevuto decine di riconoscimenti e premi in tutto il mondo, tra i quali tre Compassi d'Oro, tre German Design Award, e diciotto ADI design Index.

**EN** Founded in 1949, Caimi is one of the leading European design-oriented manufacturers of furniture and complements for the office, home and contract sectors. For **over 70 years** Caimi has continued to research and assay new solutions for the betterment of people's lives and living spaces. With its products displayed in design museums around the world, Caimi has received dozens of international awards and prizes, including three Compasso d'Oro prizes, three German Design Award, and eighteen ADI Design Index prizes.

**F** Fondée en 1949, Caimi est l'une des principales entreprises européennes de production axée sur le design, dans le domaine de l'ameublement, des accessoires de décoration et des solutions acoustiques pour le bureau, la maison et les grands projets clé en main. Depuis **plus de 70 années**, Caimi est à la recherche de nouvelles solutions pour améliorer de manière concrète la vie des personnes et de leur habitat. Présente dans les musées internationaux de design, Caimi a reçu des dizaines de prix et récompenses dans le monde entier, dont trois Compasso d'Oro, trois German Design Award et dix-huit ADI design Index.

**D** 1949 gegründet, ist Caimi eines der führenden Design-orientierten Hersteller in Europa in der Branche Einrichtung, Einrichtungszubehör und Schalldämpflösungen für Büro, Wohnen und Contract. Seit **über 70 Jahren** erforscht und experimentiert Caimi neue Lösungen, um das Leben der Menschen und die Räume, in denen sie leben, zu verbessern. In den internationale Design-Museen ausgestellt, wurde Caimi mit zahlreichen Preisen und Auszeichnungen in der ganzen Welt bedacht, darunter drei Compasso d'Oro, drei German Design Award und achtzehn ADI Design Index.

**E** Fundada en 1949, Caimi es una de las principales empresas productoras europeas dedicada al diseño en el sector del interiorismo, de los complementos decorativos y de las soluciones acústicas para oficina, hogar y contract. Desde hace **más de 70 años** Caimi sigue investigando y desarrollando novedosas soluciones para mejorar la vida de las personas y el entorno en el que viven. Con obras expuestas en museos de diseño a nivel internacional, Caimi ha recibido decenas de reconocimientos y premios en todo el mundo, entre ellos tres Compasso d'Oro, tres German Design Awards y dieciocho ADI design Index.

An always evolving company with 3 main divisions



Acoustic Products & Textiles



Office, Home & Contract Solutions



Research, Academy & No Profit



# AWARDS

Over 60 international awards



# DESIGNERS

& design

**I** Le performance acustiche dei prodotti Snowsound prendono forma nei progetti di grandi designers. Una moltitudine di forme e colori pensati sia per essere parte visibile e caratterizzante del progetto, sia per integrarsi con discrezione negli ambienti. Risolvere le problematiche acustiche, dalle più semplici alle più complesse, con una gamma integrata di prodotti basati su un approccio del tutto innovativo.

**EN** Snowsound acoustic performance takes shape in projects thanks to great designers. Many shapes and colours are designed to be a visible and distinctive part of the project or to discreetly integrate into the spaces. Resolving acoustic problems, from the simplest to the most complex, with a complete range of products based on a totally innovative approach.

**F** Les performances acoustiques de Snowsound prennent forme dans les projets des grands designers. Une multiplicité de formes et de couleurs conçus aussi bien pour être la partie visible et distinctive du projet, que pour s'intégrer discrètement dans les différents espaces. Résoudre les problématiques d'acoustique, des plus simples aux plus complexes, avec une gamme intégrée de produits basés sur une approche tout à fait innovante.

**D** Die akustische Wirkung von Snowsound nimmt in Projekten großer Designer Gestalt an. Eine Vielfalt an Formen und Farben ermöglichen die Gestaltung eines sichtbaren und charakteristischen Teil des Projekts ebenso wie eine diskrete Integration in den Räumen. Die Lösung von akustischen Problemen, von einfachen bis hin zu sehr komplexen, mit einer vollständigen Produktlinie, stellt einen vollkommen innovativen Ansatz dar.

**E** Las prestaciones acústicas de Snowsound se plasman en los proyectos de diseñadores afamados. Un sinfín de formas y colores concebidos tanto para ser parte visible que caracteriza el proyecto, como también elemento que se integra con discreción en su entorno. Solucionar los problemas acústicos, de los más sencillos a los más complejos, con una gama integrada de productos basados en un enfoque muy innovador.



Gio Ponti



Mario Trimarchi



Michele De Lucchi



Gillo Dorflès



Alessandro Mendini  
Francesco Mendini



Alberto Meda  
Francesco Meda



Felicia Arvid



Alessandro Zambelli



Manuela Zecca



Paola Navone



Sezgin Aksu



Marc Sadler



Annalisa Dominoni  
Benedetto Quaquaro



King & Miranda



Lorenzo Damiani



Claudio Bellini



Moreno Ferrari



Lorenzo Palmeri

# OPEN LAB

Research, Academy & No Profit

**I**\_Open Lab è uno spazio all'avanguardia che vanta 7 laboratori avveniristici dedicati alla ricerca teorica e applicata in ambito tecnologico, acustico e fisico. Un centro di ricerca volto a sperimentare il comportamento del suono, le capacità percettive dell'uomo e gli effetti che il suono ha sull'essere umano. In linea con le tradizioni della nostra azienda da sempre sensibile ai problemi sociali e con l'obiettivo di trovare soluzioni che contribuiscano a rendere migliore la qualità della vita, Open Lab è anche una struttura no profit gratuitamente messa al servizio di Università, Istituti di Ricerca, Fondazioni ed Enti. Open Lab, un grande laboratorio aperto al mondo, perché non esiste innovazione senza ricerca.

**EN**\_Open Lab is an advanced facility housing 7 futuristic laboratories dedicated to theoretical and applied research in technology, acoustics and physics. The purpose of the research facility is to carry out experiments on the behaviour of sound, on the perceptive capacities of humans, and on the effects of sound on people. In keeping with the traditions of our company, which has always been socially aware and has always aspired to solutions that improve the quality of life of all, Open Lab operates as a not-for-profit entity that is placed free of charge at the disposition of universities, research institutes, foundations and public-sector bodies. Open Lab: A laboratory complex whose doors are open to the world; without research, there can be no innovation.

**F**\_Open Lab est un lieu à l'avant-garde qui vante 7 laboratoires ultra-modernes dédiés à la recherche théorique et appliquée dans le domaine technologique, acoustique et physique. Un centre de recherche pour expérimenter le comportement du son, la capacité perceptive et les effets du son sur les êtres humains. En ligne avec les traditions de notre entreprise, depuis toujours sensible aux problèmes sociaux et à la recherche de solutions qui contribueront à améliorer la qualité de vie, Open Lab est en même temps une structure sans but lucratif au service des universités, instituts de recherche, fondations et autres organismes. Open Lab, un grand laboratoire ouvert au monde, car l'innovation ne peut exister sans la recherche.

**D**\_Open Lab ist ein Experimentierraum mit 7 zukunftsweisenden Labors, die sich mit theoretischer Forschung und ihrer Anwendung auf Technologie, Akustik und Physik befassen. Ziel des Forschungszentrums ist die Auslotung von Schallverhalten und menschlicher Wahrnehmung sowie der Auswirkungen von Schall auf den Menschen. Im Einklang mit der Tradition eines Unternehmens, das schon immer empfänglich war für soziale Themen und mit dem Ziel, Lösungen zu entwickeln, die zur Besserung der Lebensqualität beitragen, gestaltet sich Open Lab gleichzeitig als gemeinnützige Struktur, die kostenlos im Dienst von Universitäten, Forschungsinstituten, Stiftungen und Einrichtungen arbeitet. Open Lab ist ein großes, der Welt offenes Labor, weil es ohne Forschung keine Innovation gibt.

**E**\_Open Lab es un espacio vanguardista que cuenta con 7 laboratorios punteros orientados a la investigación teórica y aplicada en el ámbito tecnológico, acústico y físico. Un centro de investigación que permite experimentar el comportamiento del sonido, la capacidad de percepción del ser humano y los efectos que el sonido ejerce sobre este. De acuerdo con la tradición de nuestra empresa, siempre atenta a los problemas sociales y con el objetivo de encontrar soluciones que logren aportar mejoras a la calidad de vida, Open Lab es también una estructura sin ánimo de lucro que se pone al servicio de Universidades, Institutos de Investigación, Fundaciones y Entidades. Open Lab, es un gran laboratorio abierto al mundo, porque no existe innovación sin investigación.

Discover Open Lab



# SELECT AND MIX THE PRODUCTS

Our software calculates your acoustic solution

**I**\_Non solo pannelli fonoassorbenti, ma sistemi completi che comprendono illuminazione, tessuti, tendaggi e arredi: con i prodotti SNOWSOUND il progetto acustico è in grado di soddisfare le esigenze estetiche e funzionali di ogni ambiente. Il nostro software di calcolo consente di combinare tra loro tutti i prodotti del catalogo SNOWSOUND ed è in grado di eseguire un calcolo acustico che si basa su precisi test effettuati su ogni singolo prodotto. Il cliente deve semplicemente scegliere i prodotti più adatti alle proprie esigenze demandando al software di calcolo l'analisi acustica dell'ambiente. La precisione del software Snowsound è comprovata dagli oltre **100.000 calcoli acustici** effettuati nel corso degli anni, da **2 premi internazionali** ricevuti e dal nuovo laboratorio di ricerca Open Lab che permette di sviluppare ricerca sempre più avanzata.

**EN**\_Not just sound-absorbing panels, but complete systems that include lighting, fabrics, curtains and furnishings. With SNOWSOUND, the acoustic design incorporates aesthetic and functional needs for any environment. Our calculation software combines all the products in the SNOWSOUND catalogue and it performs an acoustic calculation based on precise tests carried out on each individual product. The customer simply has to choose the desired products while the calculation software takes care of the acoustic analysis and it estimates the required quantities. The precision of the software is proven by more than **100,000 acoustic calculations** made over the years, by the **2 international awards** received and by the new research laboratory Open Lab that allows to develop increasingly advanced research.

**F**\_Il ne s'agit pas seulement de panneaux phono-absorbants, mais de systèmes complets comprenant l'éclairage, les tissus, les rideaux et le mobilier: grâce aux produits SNOWSOUND, le projet acoustique peut répondre aux exigences esthétiques et fonctionnelles de tout type d'intérieur. Notre logiciel de calcul permet de combiner entre eux tous les produits du catalogue SNOWSOUND et peut effectuer un calcul acoustique basé sur des tests précis réalisés sur chacun de nos produits. Le client doit uniquement choisir les produits qui répondent au mieux à ses exigences en laissant l'analyse acoustique de la pièce au logiciel de calcul. La précision du logiciel est prouvée par les plus de **100.000 calculs acoustiques** réalisés au fil des ans, par les **2 prix internationaux** reçus et par le nouveau laboratoire de recherche Open Lab qui permet de développer davantage et des recherches plus avancées.

**D**\_Nicht nur schallabsorbierende Paneele, sondern Komplettsysteme mit Beleuchtung, Stoffen, Vorhängen und Möbeln: Mit SNOWSOUND-Produkten wird das Akustikdesign den ästhetischen und funktionalen Anforderungen eines jeden Raumes gerecht. Mit unserer Analysesoftware können sämtliche Produkte des SNOWSOUND-Katalogs miteinander kombiniert werden und eine akustische Berechnung durchgeführt werden, die auf präzisen Tests an jedem einzelnen Produkt basiert. Sie wählen lediglich die Produkte aus, die Ihren Bedürfnissen am besten entsprechen, und die Software führt die entsprechende akustische Raumanalyse durch. Die Präzision der Software wird durch mehr als **100.000 akustische Berechnungen** bewiesen, welche im Laufe der Jahre erfolgreich durchgeführt wurden. Wir erhielten **2 internationalen Auszeichnungen** und unser eigenes Forschungslabor Open Lab, das die weitere Entwicklung und Präzisierung ermöglicht.

**E**\_No solo paneles fonoabsorbentes, sino también sistemas completos que abarcan iluminación, tejidos, cortinas y elementos de decoración: con los productos SNOWSOUND el proyecto acústico se encuentra con las necesidades estéticas y funcionales de cada estancia. Nuestro software de cálculo permite combinar entre sí todos los productos de la familia SNOWSOUND y realizar un cálculo acústico basado en precisos ensayos, realizados para cada objeto en particular. El cliente debe, sencillamente, seleccionar los productos más adecuados a sus necesidades y confiar al software de cálculo el análisis acústico del ambiente. La precisión de estas herramientas se ha demostrado gracias a los más de **100,000 estudios acústicos** que se han realizado a lo largo de los años, además de por sus **2 premios internacionales** y por el nuevo Open Lab, laboratorio de investigación en el que se desarrollan investigaciones más avanzadas.

Watch the video

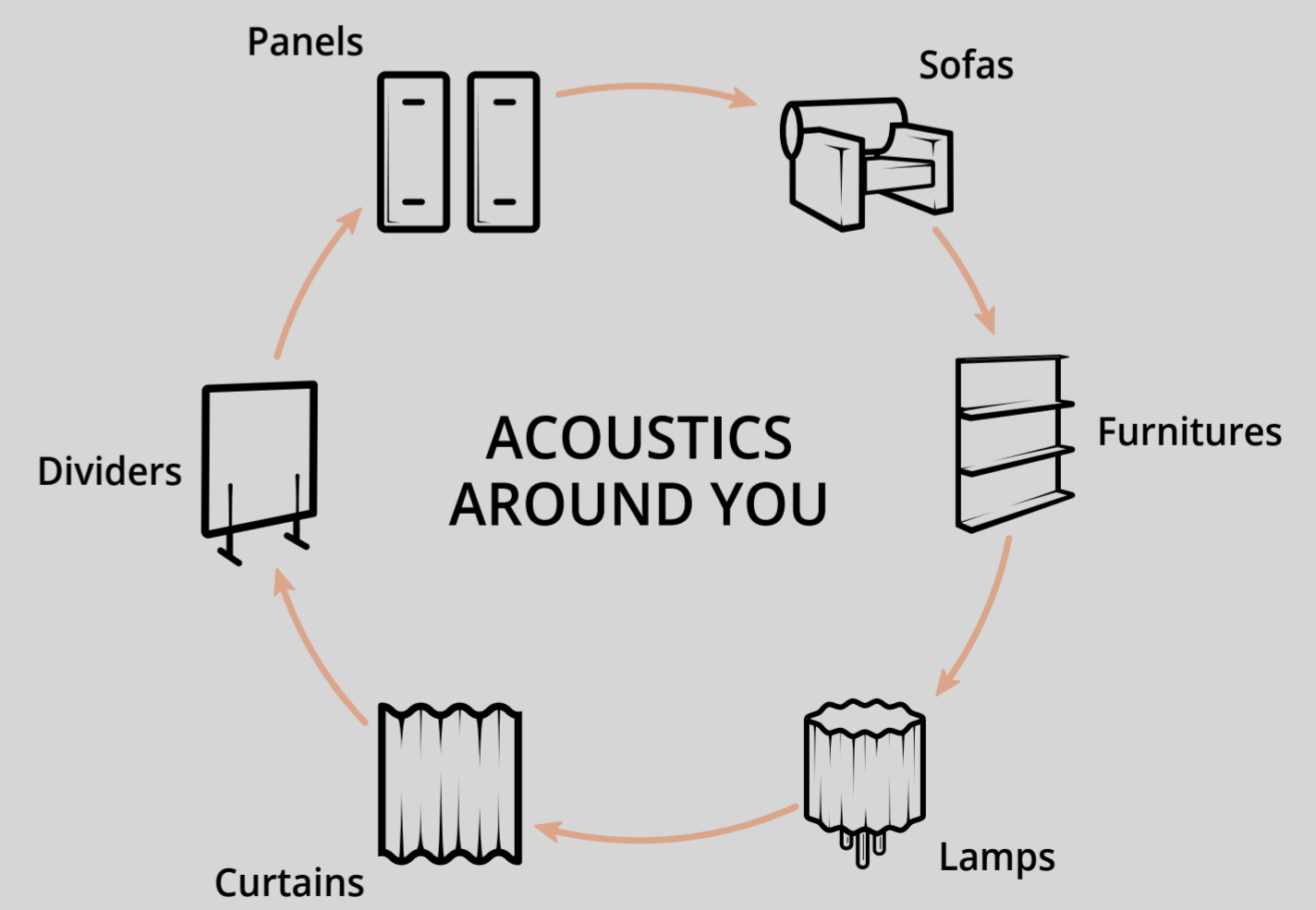

# WELLBEING TECHNOLOGIES

Acoustic comfort  
Electromagnetic reduction  
Air purification



# A+E TECHNOLOGY

Acoustic + Electromagnetic Reduction

**I**\_Tessuto riduttore di radiofrequenze a base di tecnopolimero metallizzato in argento puro, specificatamente progettato per ridurre la potenza dei campi elettromagnetici provenienti dall'esterno senza tuttavia ostacolare completamente i segnali in modo da poter continuare ad utilizzare smartphone e reti Wi-Fi. Il tessuto riduttore di radiofrequenze viene inserito all'interno di divani, oggetti e pannelli fonoassorbenti, consentendo di combinare la funzione di riduzione del riverbero acustico a quella di riduzione dei campi elettromagnetici. Una nuova tecnologia brevettata pensata per il benessere delle persone.

**EN**\_Metallized high-tech polymer fabric with pure silver for radio frequency reduction. Specifically designed to reduce the power of electromagnetic fields. However, it doesn't completely obstruct signals, allowing the use of smartphones and Wi-Fi networks. This radio frequency reducing fabric can be included inside sofas and other sound absorbing elements, combining sound absorption with reduction of electromagnetic fields. A new patented technology for the wellbeing of people.

**F**\_Tissu réducteur des radiofréquences à base de technopolymère métallisé en argent pur, conçu expressément pour réduire la puissance des champs électromagnétiques provenant de l'extérieur sans empêcher complètement les signaux, de manière à pouvoir continuer à utiliser les téléphones portables et les réseaux Wi-Fi. Le tissu réducteur de radiofréquences est ajouté à l'intérieur des canapés, objets et panneaux phono-absorbants, permettant d'associer la fonction de réduction de la réverbération acoustique avec la réduction des champs électromagnétiques. Une nouvelle technologie brevetée, pensée pour le bien-être des gens.

**D**\_Hochfrequenzreduzierendes Gewebe auf der Basis von mit reinem Silber metallisiertem Technopolymer, das speziell entwickelt wurde, um die Stärke von elektromagnetischen Feldern von außen zu reduzieren, ohne jedoch Signale vollständig zu blockieren, so dass Smartphones und WLAN-Netzwerke weiterhin genutzt werden können. Das hochfrequenzreduzierende Gewebe wird in Sofas, Gegenständen und schallabsorbierenden Paneelen eingesetzt, wodurch die Reduzierung des akustischen Halls mit der Reduzierung elektromagnetischer Felder einhergeht. Eine neue, patentierte Technologie für das Wohlbefinden der Menschen.

**E**\_Tejido reductor de radiofrecuencias realizado a partir de tecnopolímero revestido con plata pura, concebido y diseñado para reducir la potencia de los campos electromagnéticos provenientes del exterior, sin bloquear por completo las señales para permitir, así, el funcionamiento de teléfonos móviles y redes Wi-Fi. El tejido reductor de radiofrecuencias se incorpora en el interior de sofás, paneles u objetos fonoabsorbentes, haciendo posible la combinación de las funciones de reducción de la reverberación acústica con la reducción de los campos electromagnéticos. Una novedosa tecnología patentada pensada para mejorar el bienestar de las personas.

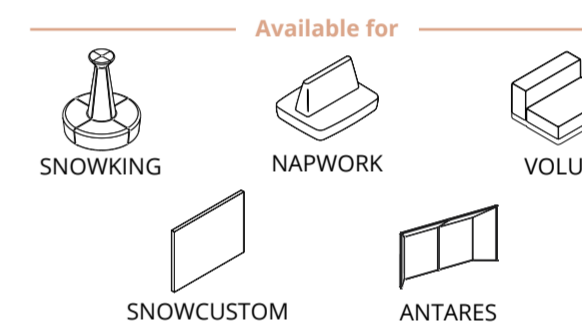

# SNOWSOUND

Acoustic comfort

**I**\_Il comfort acustico è un'esigenza di benessere che riguarda tutti gli ambienti del vivere quotidiano. I pannelli e i tessuti fonoassorbenti Snowsound permettono di correggere in maniera rapida, funzionale e sicura i problemi legati all'acustica di ristoranti, bar, hotel, uffici, aree di attesa o di transito, ambienti pubblici e biblioteche, ma anche negozi e case. Lasciatevi ispirare dalle nostre proposte!

**EN**\_Acoustic comfort is fundamental for wellbeing within all environments in our daily lives. Snowsound sound absorbing panels and fabrics can solve acoustic-related problems in a quick, functional and safe way. This is achievable in restaurants, bars, hotels, offices, waiting/transit areas, public places and libraries, stores and houses. Let yourself be inspired by our designs!

**F**\_Le confort acoustique est une exigence pour le bien-être, qui concerne tous les lieux de la vie de tous les jours. Les panneaux et tissus phono-absorbants Snowsound permettent de corriger de manière rapide, fonctionnelle et en toute sécurité les problèmes liés à l'acoustique des restaurants, bars, hôtels, bureaux, zones d'attente ou de transit, lieux publics et bibliothèques, mais aussi des magasins et des habitations. Laissez-vous inspirer par nos propositions!

**D**\_Akustisches Wohlbefinden ist eine Anforderung, die alle Räume des Alltagslebens erfüllen müssen. Die Snowsound Schalldämpf-Platten und -Stoffe ermöglichen eine schnelle, effiziente und sichere Korrektur der Akustikprobleme von Restaurants, Bars, Hotels, Büros, Warte- oder Durchgangsräumen, öffentlichen Räumen und Bibliotheken, aber auch von Läden und Wohnungen. Lassen Sie sich von unseren Vorschlägen inspirieren!

**E**\_El confort acústico de todos los ambientes del diario vivir es una necesidad de bienestar. Los paneles y tejidos fonoabsorbentes Snowsound posibilitan la corrección rápida, funcional y segura de los problemas relacionados con la acústica de restaurantes, cafeterías, hoteles, oficinas, zonas de espera o de tránsito, locales públicos y bibliotecas, pero también de tiendas y viviendas. ¡Inspiraos en nuestras propuestas!

# AIR PURIFICATION TECHNOLOGY

**I**\_Il calore della lampada riscalda l'aria nella parte superiore generando un moto convettivo. L'aria così riscaldata passa attraverso un filtro realizzato in maglia di alluminio, galvanizzato e trattato con ioni d'argento, purificandosi.

**EN**\_The lamp heats the air in the upper part, generating a convective motion. The heated air passes through a filter made of galvanized aluminum mesh, treated with silver ions, purifying itself.

**F**\_La chaleur d'une lampe réchauffe l'air dans la partie supérieure, en créant un mouvement convectif. Cet air chaud est purifié en passant à travers un filtre en maille d'aluminium galvanisé et traité aux ions d'argent.

**D**\_Die Wärme der Lampe erhitzt die Luft im oberen Bereich und erzeugt eine Konvektionsbewegung. Die so erwärmte Luft strömt durch einen Filter aus galvanisiertem Aluminiumgewebe, das mit Silberionen behandelt wurde, und wird so gereinigt.

**E**\_La lámpara calienta el aire en la parte superior, generando un movimiento convectivo. El aire caliente pasa a través de un filtro de malla de aluminio galvanizado, tratado con iones de plata, purificándose.



- 1** **I**\_Filtro di purificazione dell'aria.  
**EN**\_Air purification filter.  
**F**\_Filtre de purification de l'air.  
**D**\_Luftreinigungsfiler.  
**E**\_Filtro de purificación del aire.

- 2** **I**\_Corpo illuminante LED.  
**EN**\_LED element.  
**F**\_Corps d'éclairage à LED.  
**D**\_LED-Leuchtkörper.  
**E**\_Cuerpo de iluminación LED.

- 3** **I**\_Flusso dell'aria.  
**EN**\_Air flow.  
**F**\_Flux d'air.  
**D**\_Luftstrom.  
**E**\_Flujo de aire

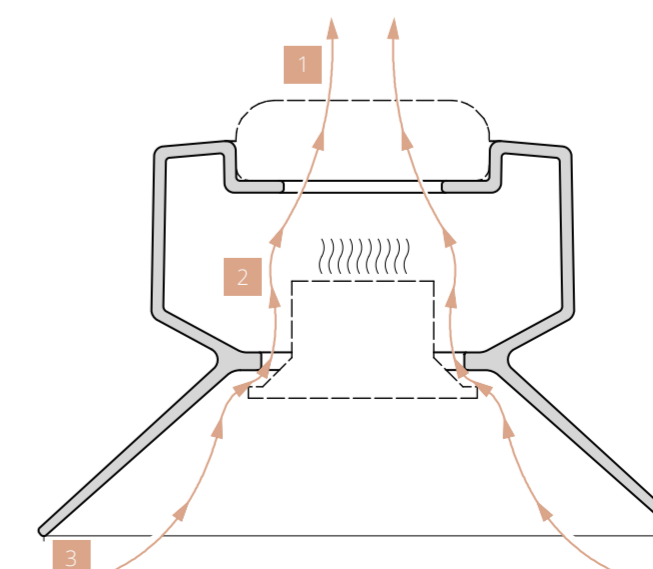

Without / with  
Snowsound Panels



Without / with  
Snowsound Fiber Textiles



Without / with  
Snowsound Sofas



# SNOWSOUND TECHNOLOGY

## Acoustic panels & products

**I** La brillante intuizione alla base della tecnologia brevettata Snowsound è l'utilizzo di pannelli composti da materiale a densità variabile, che permette di ottenere un assorbimento selettivo alle diverse frequenze e quindi di ottimizzare l'acustica dell'ambiente nonostante lo spessore molto contenuto dei pannelli. L'assenza di cornici e cuciture e la peculiarità del materiale con cui sono realizzati i pannelli, li rendono estremamente leggeri, poco ingombranti e adattabili ad ogni ambiente.

**EN** The brilliant intuition at the heart of Snowsound patented technology is based on the use of panels composed of material with variable density, which achieve selective absorption at different frequencies and thus optimise the acoustical environment notwithstanding the thinness of the panels. The absence of frames and seams and the unusual characteristics of the material used in the fabrication of the panels, render them extremely light, unobtrusive and adaptable to any environment.

**F** La brillante intuizione à la base de la technologie brevetée Snowsound pré-voit l'emploi des panneaux en particules à densité variable, qui permet d'obtenir une absorption sélective aux différentes fréquences et par conséquent d'optimiser l'acoustique des espaces, malgré l'épaisseur très mince des panneaux. L'absence de cadres et de coutures et la spécificité du matériel de base en font des panneaux très légers, peu encombrants et qui s'adaptent très bien à tout espace.

**D** Die Grundlage der patentierten Snowsound Technologie besteht aus der Verwendung von Materialien unterschiedlicher Dichte. Diese Materialien absorbieren die unterschiedlichsten Frequenzbereiche und ermöglichen trotz geringer Materialstärke eine Verbesserung der Raumakustik. Die Snowsound Paneele sind, ohne Rahmen oder Nähte, aus einem Stück gefertigt, besonders leicht und passen sich an jedes Ambiente an.

**E** La brillante intuición a la base de la tecnología patentada Snowsound es el uso de paneles compuestos por materiales de densidad variable, que permite obtener una absorción selectiva en las diversas frecuencias y entonces optimizar la acústica del ambiente, a pesar del espesor muy reducido de los paneles. La ausencia de marcos y costuras y la peculiaridad del material con el que son realizados los paneles, lo vuelven muy livianos, poco voluminosos y adaptables para todos ambientes.

- 1 **I** Tessuto di poliester.  
**EN** Polyester fabric.  
**F** Tissu en polyester.  
**D** Polyesterstoff.  
**E** Tejido de poliéster.
- 2 **I** Poliestere ad alta densità.  
**EN** High density polyester.  
**F** Polyester à haute densité.  
**D** Polyester mit hoher Dichte.  
**E** Poliéster de alta densidad.
- 3 **I** Poliestere a media densità.  
**EN** Medium density polyester.  
**F** Polyester à moyenne densité.  
**D** Polyester mit mittlerer Dichte.  
**E** Poliéster de mediana densidad.
- 4 **I** Poliestere a bassa densità.  
**EN** Low density polyester.  
**F** Polyester à basse densité.  
**D** Polyester mit niedriger Dichte.  
**E** Poliéster de baja densidad.
- 5 **I** Bordo rigido.  
**EN** Rigid edge.  
**F** Bord rigide.  
**D** Feste Kante.  
**E** Borde rígido.

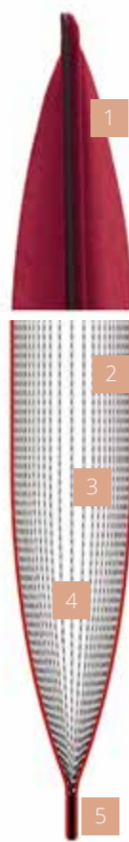

Experience the difference



Without / With Snowsound Technology

# SNOWSOUND FIBER TEXTILES

## Acoustic fabrics

**I** La tecnologia brevettata Snowsound Fiber è basata su morbide fibre acustiche di poliester intrinsecamente ignifughe e interconnesse tra loro. L'interazione tra le fibre di Snowsound Fiber e l'aria permette di controllare il riverbero regolando con precisione la risposta acustica dell'ambiente in base alle modalità di posa, alla superficie e alla distanza tra le fibre e la parete, consentendo di ridurre il fastidioso riverbero acustico negli ambienti, migliorando la qualità della vita e del lavoro.

**EN** The patented Snowsound Fiber technology is based on soft interwoven polyester acoustic fibers that are inherently fire-resistant. The interaction between Snowsound Fiber and air allows controlling reverberation while adjusting the environment's acoustics with precision taking advantage of installation modes, product's surface and distance from the wall. This reduces the annoying acoustic reverberation improving quality both of life and of work.

**F** La technologie brevetée Snowsound Fiber se base sur des fibres acoustiques très souples de polyester entrelacées et intrinsèquement ignifuges. L'interaction entre les fibres de Snowsound Fiber et l'air permet de contrôler la réverbération en réglant avec précision la réponse acoustique de l'espace selon la méthode d'installation, la surface et la distance entre les fibres et le mur. Ainsi faisant on réduit la réverbération acoustique fastidieuse de la pièce en améliorant donc la qualité de vie et du travail.

**D** Die patentierte Technologie Snowsound Fiber basiert auf weichen, akustischen, innerlich feuerfesten und eng miteinander verbundenen Polyester-Fibern. Die Interaktion zwischen Snowsound Fiber und der Luft erlaubt es, den Widerhall zu kontrollieren und die akustische Antwort des Raums auf der Grundlage des Verlegungsmodus, der Fläche und der Distanz zwischen Fibern und Wand präzise zu regulieren, und somit den störenden Widerhall von Räumen zu verringern und dadurch die Lebens- und Arbeitsqualität zu verbessern.

**E** La tecnología patentada Snowsound Fiber se basa en suaves fibras acústicas de poliéster entrelazadas, intrínsecamente resistentes al fuego. La interacción entre Snowsound Fiber y el aire permite controlar la reverberación mientras ajusta la acústica del entorno con precisión, aprovechando los modos de instalación, la superficie del producto y la distancia desde la pared. Esto atenúa la molesta reverberación acústica en los ambientes, mejorando la calidad de la vida y del trabajo.



Experience the difference



Without / With Snowsound Fiber Textiles

Snowsound software

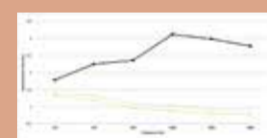

Research & patents



"A" Class

UNI EN ISO 354 (UNI EN ISO 11564)

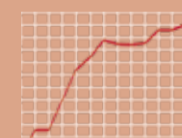

Decibels reduction



Sound quality

UNI EN ISO 10534-2



100% sound absorbing



Strong, light & thin



Greenguard Gold



Eco-friendly



No formaldehyde

UNI EN 717-2



Hygiene & maintenance



CE

EN 13964 - Regulation (UE) no. 305/2011 for ceiling fixing



Fire

Euroclass B-s2, d0



Extreme conditions

ISO 9142



Snowsound software

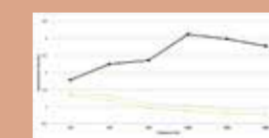

Decibels reduction "Rw index"



Research & patents



Acoustic performance

UNI EN ISO 354 (UNI EN ISO 11564)

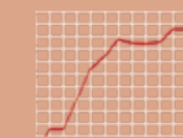

Sound quality

UNI EN ISO 10534-2



Greenguard Gold



Eco-friendly



No formaldehyde

UNI EN 717-2



Fire

Euroclass B-s2, d0 or B-s1, d0



Hygiene & maintenance



# SNOWSOUND SOFAS

## Acoustic sofas

**I**\_Divani, poltrone, pouf e tavolini fonoassorbenti progettati per migliorare con efficacia il benessere acustico negli ambienti, grazie all'impiego delle tecnologie e dei materiali Snowsound che testimoniano come l'acustica sia parte integrante del progetto arredo.

**EN**\_Sofas, armchairs, poufs and sound-absorbing coffee tables designed to effectively improve the acoustic wellbeing of indoor spaces. This is possible thanks to the use of Snowsound technologies and materials that confirm how acoustics is an integral part of the furniture project.

**F**\_Canapés, fauteuils, poufs et tables basses phono-absorbants conçus pour améliorer de manière efficace le confort acoustique dans les pièces, grâce à l'utilisation des technologies et des matériaux Snowsound qui montrent comment l'acoustique fait partie intégrante de la conception du mobilier.

**D**\_Schallabsorbierende Sofas, Sessel, Hocker und Beistelltische, die das akustische Wohlbefinden in Räumen dank der Verwendung von Snowsound-Technologien und -Materialien effektiv verbessern und die Bedeutung der Akustik als unerlässlicher Bestandteil des Einrichtungsprojekts belegen.

**E**\_Sofás, sillones, puffs y mesitas fonoabsorbentes, diseñados para mejorar de forma eficiente el bienestar acústico de los espacios, gracias al uso de las tecnologías y materiales Snowsound que demuestran el protagonismo de la acústica como parte integrante de los proyectos de decoración.

Experience  
the difference



Without / With  
Snowsound Sofas

Caimi Open Lab, Rev Lab  
Reverberation Chamber



Caimi Open Lab, Supernova Lab,  
Semi-anechoic Chamber



**SNOWKING**  
(a+b) Annalisa Dominoni  
Benedetto Quaquaro



**NAPWORK**  
Paola Navone - Otto Studio



**VOLUMI**  
Caimi Lab



**CILINDRO**  
Claudio Bellini



**SNOWSOFA**  
Sezgin Aksu



**SNOWPOUF**  
Paola Navone - Otto Studio



**FULCRO**  
Claudio Bellini



**SNOWKING**  
(a+b) Annalisa Dominoni  
Benedetto Quaquaro

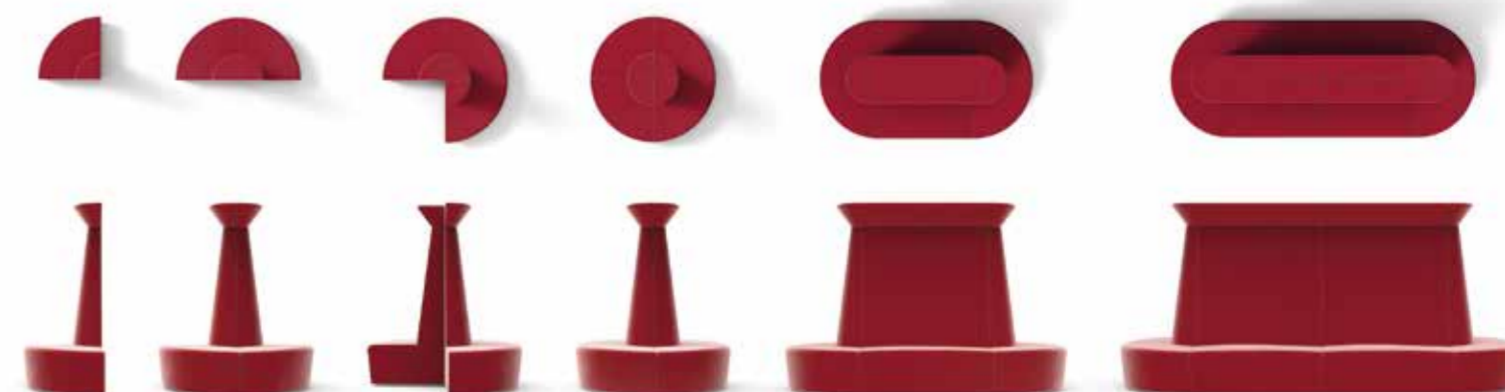



**CILINDRO**  
Claudio Bellini



**FULCRO**  
Claudio Bellini



**SNOWPOUF**  
Paola Navone - Otto Studio



**NAPWORK**  
Paola Navone - Otto Studio



**VOLUMI**  
Caimi Lab

# SNOWSOUND FIBER

## Acoustic textiles

**I** I materiali Snowsound Fiber, a seconda delle loro specifiche tecniche, possono essere inseriti in diversi ambienti, connotandone lo stile e diventando parte integrante del progetto d'arredo. I materiali Snowsound Fiber sono proposti in diverse tipologie per diversi utilizzi; si possono lavorare e posare in opera in modo creativo, creando anche effetti d'arredo coordinati.

**EN** Snowsound Fiber materials have different technical properties, thus permitting different uses for different environments, characterizing with style of a given space and becoming part of the interior design. Therefore Snowsound Fiber materials come with different features according to the need; it can be installed in creative ways in coordination with the furniture.

**F** Les matériaux Snowsound Fiber, en fonction des leurs propriétés techniques, peuvent être placés dans des espaces différents, en en caractérisant le style et devenant partie du projet d'ameublement. Les matériaux Snowsound Fiber sont disponibles dans différents types pour différents emplois: on peut façonner les tissus et les utiliser d'une manière créative, créant également des effets décoratifs coordonnés.

**D** Snowsound Fiber-Materialien können, je nach Ihren spezifischen technischen Eigenschaften, in verschiedenen Räumen Einsatz finden, indem sie deren Stil definieren und zum wesentlichen Bestandteil des Einrichtungsentwurfs werden. Snowsound Fiber-Materialien werden in verschiedenen Modellen für verschiedenartige Einsätze geliefert; sie können kreativ verlegt und verarbeitet werden, auch um koordinierte Einrichtungseffekte zu erzeugen.

**E** Los materiales Snowsound Fiber poseen diferentes propiedades técnicas que permiten diferentes usos para diferentes entornos, confiriendo carácter y estilo a los diferentes espacios y formando parte del diseño de interiores. De esta forma, los materiales Snowsound Fiber se puede aplicar en diferentes configuraciones de acuerdo a las necesidades; puede instalarse de forma creativa en conjunto con el resto del mobiliario.



Watch the video

BMW Financial Service – "Central Spine", Milano (Italy)



The Splash Lab (U.S.A.)



FIBER 8 BOUCLÈ



FIBER 3 MELANGE

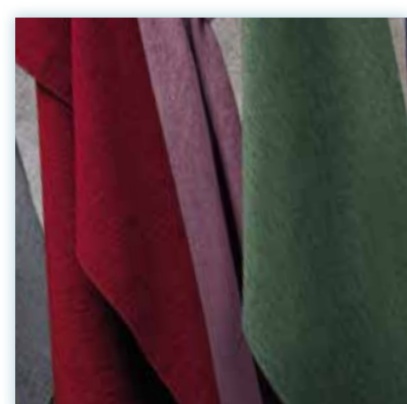

FIBER 6 VELVET



FIBER 1 COLOR



FIBER 2 LINE



FIBER 2R LINE-R



SNOWCURTAINS (CUSTOM MADE)

# SNOWCURTAINS

## Custom made acoustic curtains

**I** Tende realizzate con tessuti fonoassorbenti Snowsound Fiber, prodotte su misura in base alle specifiche esigenze del cliente. Per dimensioni e tipologia di confezionamento consultare il sito [www.caimi.com](http://www.caimi.com).  
Tipologie differenti di tende possono essere realizzate a cura del cliente utilizzando l'ampia gamma di tessuti fonoassorbenti Snowsound Fiber.

**EN** Curtains made with Snowsound Fiber sound-absorbing fabrics, made to measure according to the specific needs of the customer. For dimensions and sewing types, please consult the website [www.caimi.com](http://www.caimi.com).  
Different types of curtains can be made by the customer using the wide range of Snowsound Fiber sound-absorbing fabrics.

**F** Rideaux en tissus phono-absorbants Snowsound Fiber, fabriqués sur mesure selon les besoins spécifiques du client. Pour les dimensions et le type de confection, consultez le site [www.caimi.com](http://www.caimi.com).  
Différents types de rideaux peuvent être réalisés par le client en utilisant la large gamme de tissus phono-absorbants Snowsound Fiber.

**D** Vorhänge aus Snowsound Fiber Akustikstoffen, maßgeschneidert nach Kundenwunsch. Für die verfügbaren Maße und Ausführungen dürfen wir auf unsere Website [www.caimi.com](http://www.caimi.com) verweisen.  
Unter Verwendung der breiten Auswahl an Snowsound Fiber Akustikstoffen hat der Kunde die Möglichkeit verschiedene Arten von Vorhängen zu gestalten.

**E** Cortinas realizadas con tejidos fonoabsorbentes Snowsound Fiber, hechas a medida según las especificaciones del cliente. Para conocer las dimensiones y los tipos de confección, consulte la web [www.caimi.com](http://www.caimi.com).  
Se pueden confeccionar diferentes tipos de cortinas según las especificaciones del cliente utilizando la amplia gama de tejidos fonoabsorbentes Snowsound Fiber.



Gensler, Miami (U.S.A.)



# WALL PRODUCTS



**BOW**  
King & Miranda



**SNOWGEMS**  
(a+b) Annalisa Dominoni  
Benedetto Quaquaro

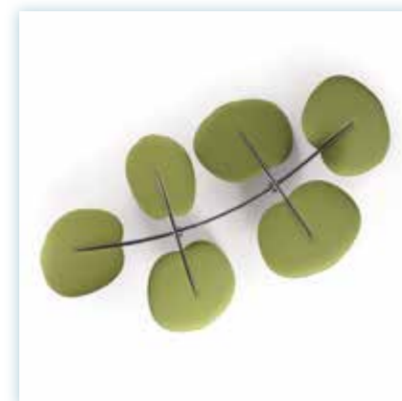

**BOTANICA**  
Mario Trimarchi



**BOTANICA**  
Mario Trimarchi



**TRI BU**  
Paola Navone - Otto Studio



**CLIMBING**  
Raffaello Manzoni



**FLAT**  
Alberto Meda  
Francesco Meda



**KLIPPER**  
Felicia Arvid



**MITESCO**  
Michele De Lucchi



**FLAP**  
Alberto Meda  
Francesco Meda



**GIOTTO**  
Sezgin Aksu



**SNOWCUSTOM**  
Caimi Lab



**SNOWFIX**  
Caimi Lab



**SNOWFIX EASY**  
Caimi Lab



**BLADE**  
Lorenzo Damiani



**ANTARES**  
Manuela Zecca



**CLASP WALL**  
(a+b) Annalisa Dominoni  
Benedetto Quaquaro



**SNOWALL**  
Caimi Lab



**SNOWMAGNET**  
Caimi Lab



**SNOWMAGNET EASY**  
Caimi Lab



**COCKER**  
Caimi Lab



**PINNA**  
(a+b) Annalisa Dominoni  
Benedetto Quaquaro



**BEMOLLE**  
Atelier Mendini



**SI SBOCCIA**  
Moreno Ferrari



**FLAT**  
Alberto Meda, Francesco Meda

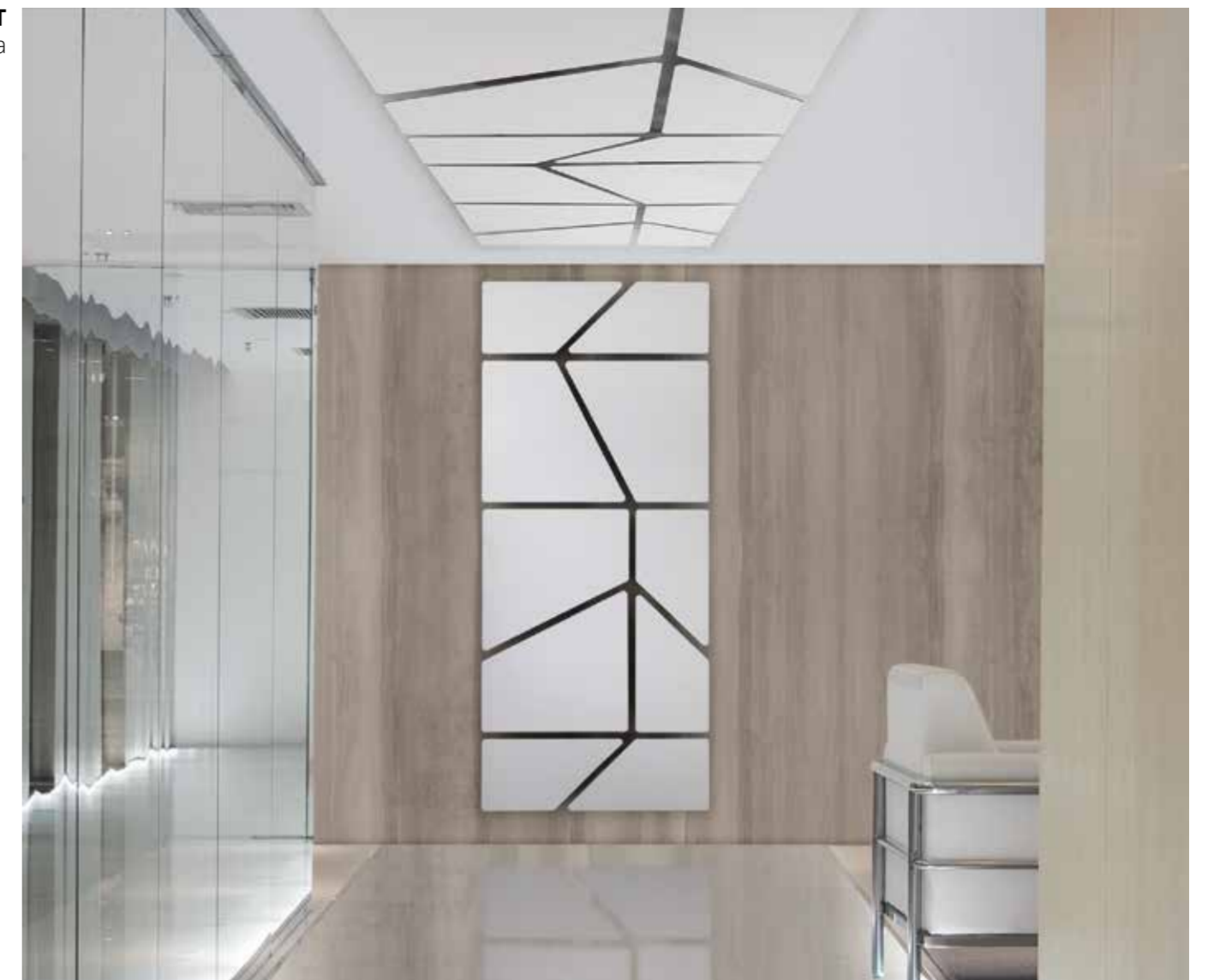

**CLIMBING**  
Raffaello Manzoni

**TRI BU**  
Paola Navone - Otto Studio



**KLIPPER**  
Felicia Arvid  
PREMIO  
COMPASSO D'ORO A&A



**FLAP**  
Alberto Meda, Francesco Meda  
PREMIO  
COMPASSO D'ORO A&A

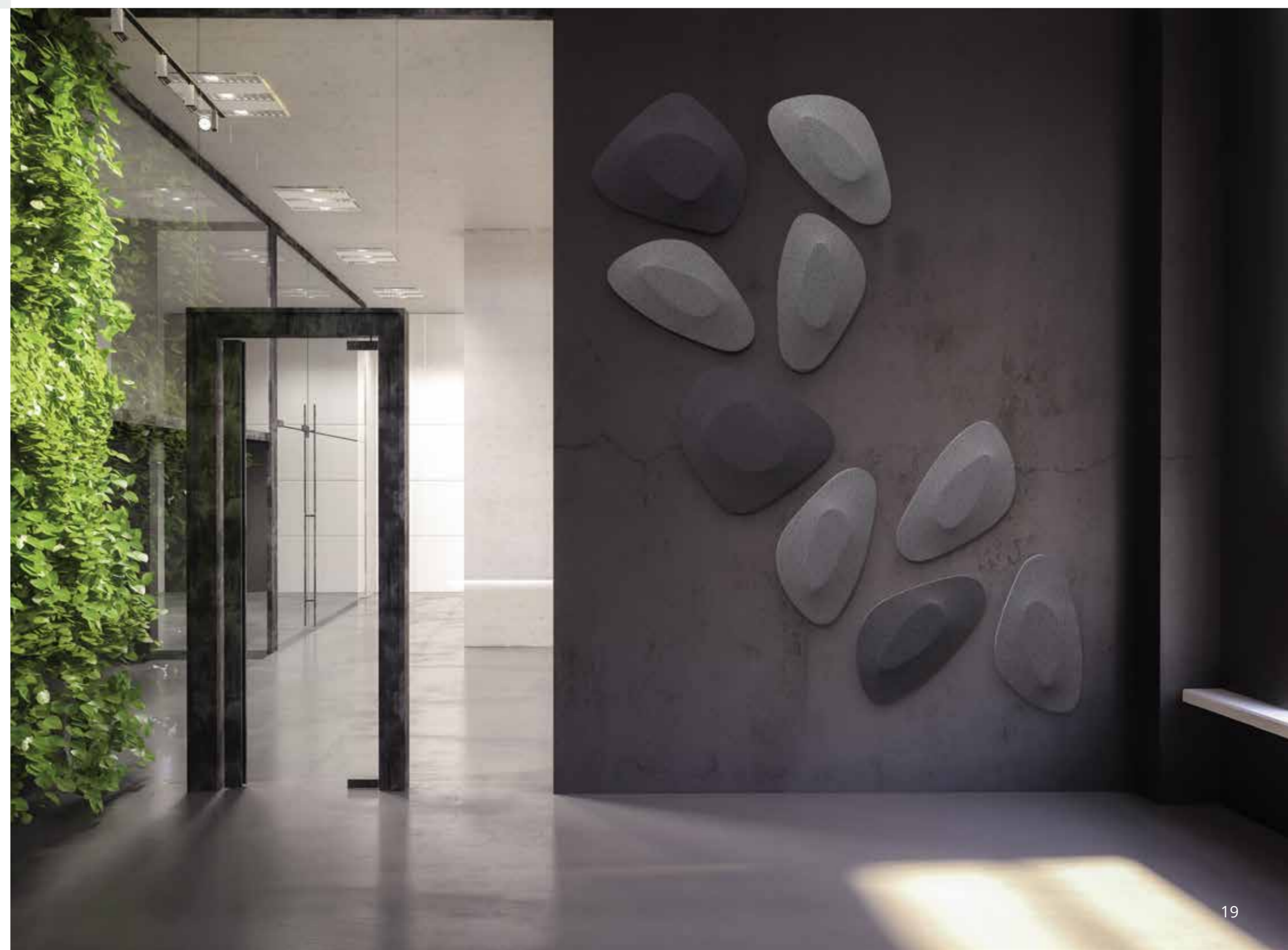



**MITESCO**  
Michele De Lucchi  
Medtronic Italia, Milano (Italy)



**SNOWCUSTOM**  
Caimi Lab

**SNOWCUSTOM**  
Caimi Lab

**BOW**  
King & Miranda



**SNOWFIX**  
Caimi Lab



# CEILING PRODUCTS



**BOW**  
King & Miranda



**FLOAT**  
Alberto Meda  
Francesco Meda



**FLAT**  
Alberto Meda  
Francesco Meda



**OVERSIZE / SNOWSOUND CEILING**  
Caimi Lab



**OVERSIZE / SNOWSOUND CEILING CABLES**  
Caimi Lab



**SNOWCUSTOM**  
Caimi Lab



**BOTANICA CEILING**  
Mario Trimarchi



**BOTANICA**  
Mario Trimarchi



**TL**  
design by Gio Ponti



**GIOTTO**  
Sezgin Aksu



**FLAP**  
Alberto Meda  
Francesco Meda

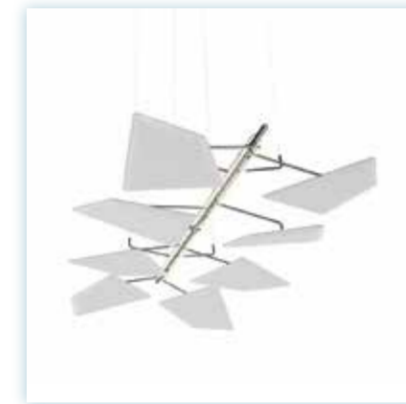

**FLAP CEILING**  
Alberto Meda  
Francesco Meda



**FLAP CHAIN**  
Alberto Meda  
Francesco Meda

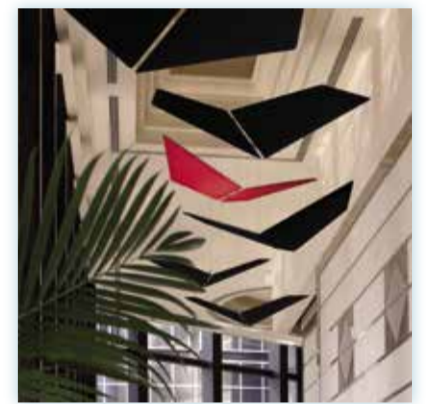

**V-FLAP**  
Alberto Meda  
Francesco Meda

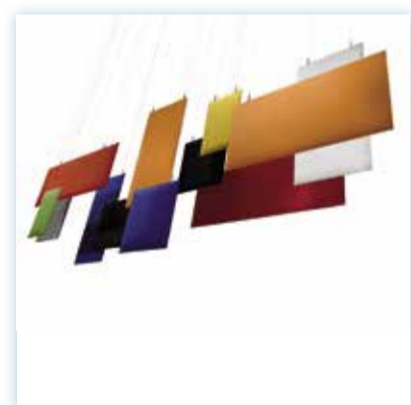

**BAFFLE**  
Marc Sadler



**BAFFLE OVERSIZE**  
Marc Sadler



**BAFFLE DIRECT 22-44**  
Marc Sadler



**SNOWGEMS**  
(a+b) Annalisa Dominoni  
Benedetto Quaquaro



**IN**  
Caimi Lab



**PAGODA**  
Caimi Lab



**SI SBOCCIA CEILING**  
Moreno Ferrari



**PINNA**  
(a+b) Annalisa Dominoni  
Benedetto Quaquaro



**TRA**  
Marc Sadler



**TRA LIGHT**  
Marc Sadler



**MITESCO**  
Michele De Lucchi



**DIESIS**  
Atelier Mendini



**CLASP RING**  
(a+b) Annalisa Dominoni  
Benedetto Quaquaro

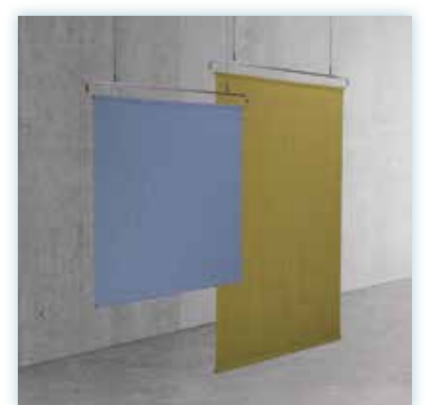

**CLASP CEILING**  
(a+b) Annalisa Dominoni  
Benedetto Quaquaro



**BOTANICA CEILING**  
Mario Trimarchi  
Residential building, Chicago (U.S.A.)



**OVERSIZE / SNOWSOUND CEILING**  
Caimi Lab  
Artisa Architettura, Lamone (Switzerland)



**OVERSIZE / SNOWSOUND CEILING CABLES**  
Caimi Lab  
Medtronic Italia, Milano (Italy)

**GIOTTO**  
Sezgin Aksu



**MITESCO**  
Michele De Lucchi  
AXA Assicurazioni, Milano (Italy)

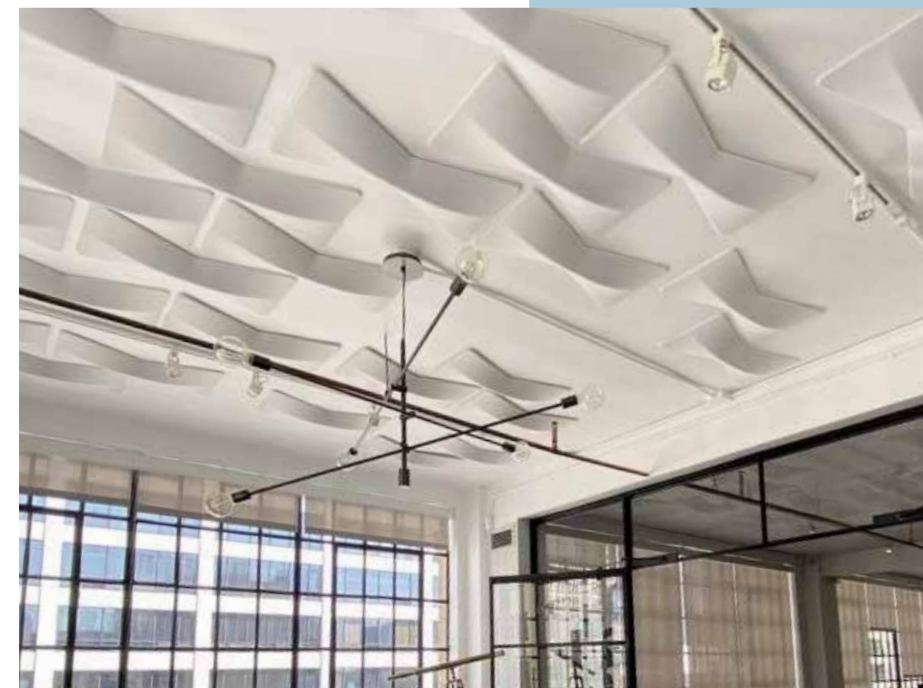

**BOW**  
King & Mirada  
Tangram Interiors, Los Angeles (U.S.A.)





**CLASP RING**  
(a+b) Annalisa Dominoni  
Benedetto Quaquaro

**FLOAT**  
Alberto Meda, Francesco Meda



**PAGODA**  
Caimi Lab

**BAFFLE DIRECT 22**  
Marc Sadler  
Sisal, Milano (Italy)



**V-FLAP**  
Alberto Meda, Francesco Meda  
Gruppo Generali Spa, Mogliano Veneto (Italy)



# DESK & DIVIDERS PRODUCTS



**CORNER**  
Marc Sadler



**PLI**  
Marc Sadler

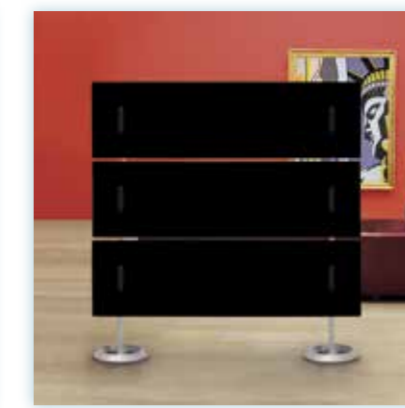

**MITESCO DIVIDERS**  
Michele De Lucchi



**SEPÀ**  
Sezgin Aksu



**SEPÀ ROLLS**  
Sezgin Aksu



**SNOWGEMS**  
(a+b) Annalisa Dominoni  
Benedetto Quaquaro



**CLASP DIVIDER**  
(a+b) Annalisa Dominoni  
Benedetto Quaquaro



**TRA LIGHT**  
Marc Sadler



**CORNER**  
Marc Sadler



**MINIMAL**  
Caimi Lab



**MITESCO DESK**  
Michele De Lucchi



**PLI DESK**  
Marc Sadler



**SNOWFRONT**  
Caimi Lab



**OVERSIZE DESK**  
Caimi Lab



**PLI OVERSIZE**  
Marc Sadler



**PLI OVER**  
Marc Sadler



**PLI OVER**  
Marc Sadler



**TRA LIGHT**  
Marc Sadler

**SNOWGEMS**  
(a+b) Annalisa Dominoni  
Benedetto Quaquaro



**CLASP DIVIDER**  
(a+b) Annalisa Dominoni  
Benedetto Quaquaro



**SEPÀ ROLLS**  
Sezgin Aksu



**MITESCO DIVIDER**  
Michele De Lucchi





# TOTEM PRODUCTS



**SNOWGEMS**  
(a+b) Annalisa Dominoni  
Benedetto Quaquaro



**BOTANICA TOTEM**  
Mario Trimarchi



**FLAT TOTEM**  
Alberto Meda  
Francesco Meda



**FLAP TOTEM**  
Alberto Meda  
Francesco Meda



**MITESCO TOTEM**  
Michele De Lucchi



**DIESIS**  
Atelier Mendini



**OBELISCO**  
design by Gio Ponti

**BOTANICA TOTEM**  
Mario Trimarchi

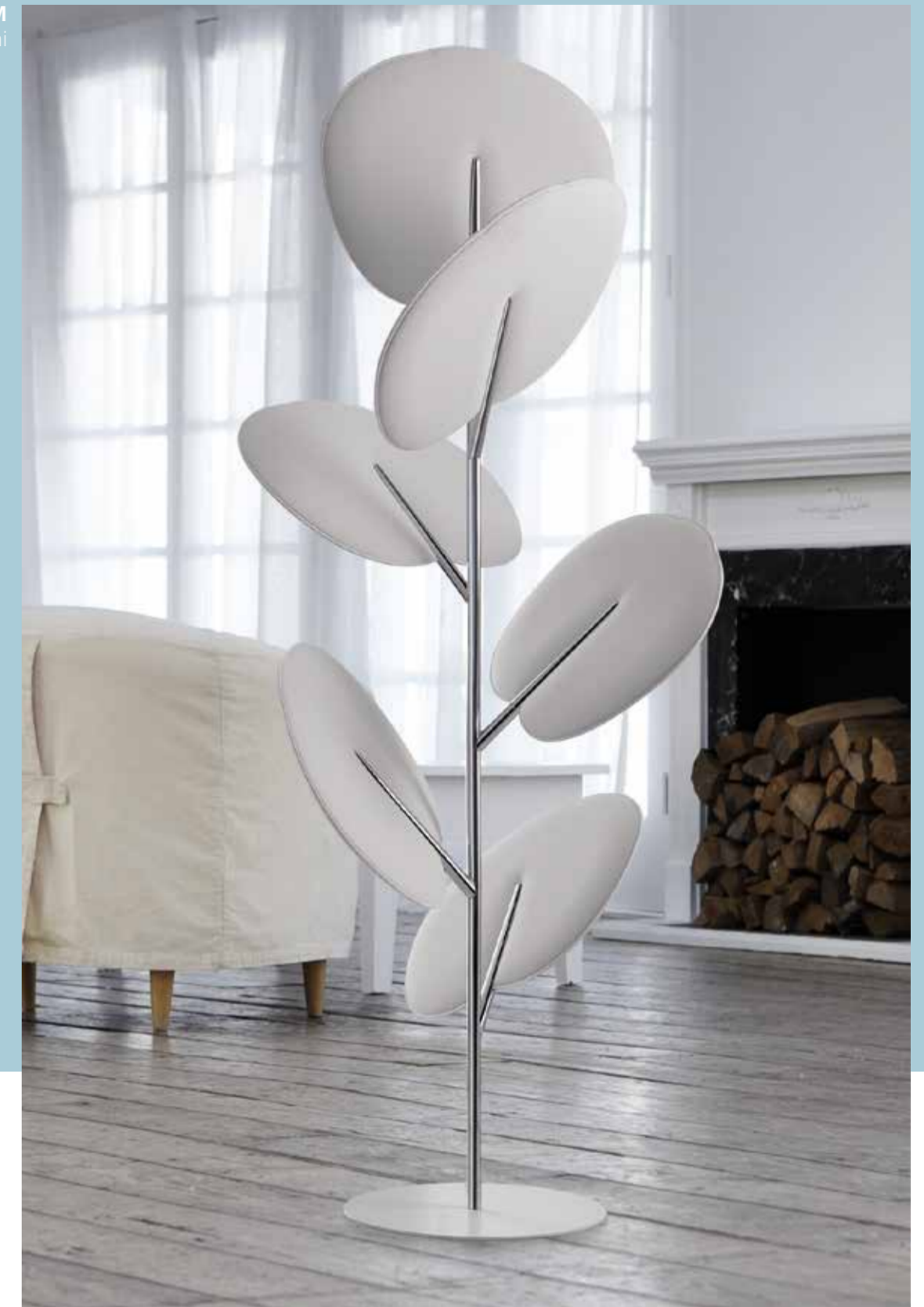

**SNOWGEMS**  
(a+b) Annalisa Dominoni  
Benedetto Quaquaro



**FLAT TOTEM**  
Alberto Meda, Francesco Meda



**FLAP TOTEM**  
Alberto Meda, Francesco Meda

# LIGHTING SYSTEMS



**GIOTTO LUX**  
Sezgin Aksu



**OVERSIZE LUX**  
Marc Sadler



**TL LUX**  
design by Gio Ponti



**FLAP LUX**  
Alberto Meda  
Francesco Meda



**FLAP CEILING LUX**  
Alberto Meda  
Francesco Meda



**FLAT LUX**  
Alberto Meda  
Francesco Meda



**CLASP RING / SOL**  
Dominoni, Quaquaro  
Caimi Lab



**CLASP RING / SCALA**  
Dominoni, Quaquaro  
Caimi Lab



**GIOTTO / SCALA**  
Sezgin Aksu  
Caimi Lab

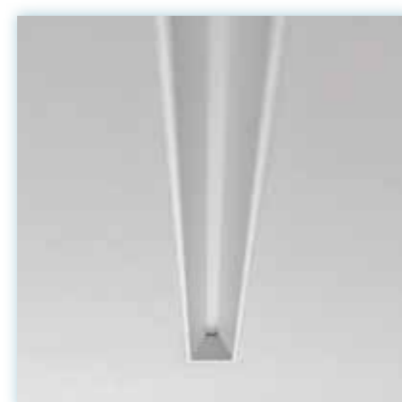

**T-SYSTEM**  
Marc Sadler



**T-SYSTEM TRACK**  
Marc Sadler



**TELETA**  
Alessandro Zambelli



**OVERSIZE LUX**  
Marc Sadler



**GIOTTO LUX**  
Sezgin Aksu

**FLAT LUX**  
Alberto Meda, Francesco Meda



# SNOWSOUND ART

I\_Snowsound Art è un progetto di Caimi che ha come obiettivo un viaggio alla scoperta di nuove strade per far dialogare ARTE e DESIGN. Un modo di vedere l'arte, non solo come una creazione unica, non ripetibile, ma come una "bellezza" riproducibile su oggetti seriali. L'arte non solo da contemplare, l'arte da fruire. Nel 2020 due opere di Gillo Dorfles sono entrate a far parte della collezione permanente di Arte e Design del Quirinale (Residenza del Presidente della Repubblica Italiana).

EN\_Snowsound Art is a Caimi project that aims to be a journey of discovery, looking for new ways to bring ART and DESIGN together. A way of interpreting art not just as a unique creation that can't be repeated, but as a form of beauty that can be reproduced on serial objects. Art isn't just to be contemplated. It is to be enjoyed as well. In 2020, two designs by Gillo Dorfles were added to the permanent Art and Design collection at the Italian President's official residence in Rome, the Quirinale Palace.

F\_Snowsound Art est un projet de Caimi proposant un voyage à la découverte de nouvelles voies pour établir un dialogue entre l'ART et le DESIGN. Une manière de voir l'art non seulement comme une création unique, non répétable, mais comme une "beauté" reproductible sur des objets en série. L'art non seulement destiné à être contemplé, mais à être utilisé. En 2020 deux œuvres de Gillo Dorfles ont intégré la collection permanente de Art et Design du Quirinal (la résidence du Président de la République italienne).

D\_Snowsound Art ist ein Projekt von Caimi als Entdeckungsreise auf der Suche nach neuen Wegen mit dem Ziel, Kunst und Design zusammenzuführen. Dabei wird Kunst nicht nur als einmalige, unwiederholbare Schöpfung betrachtet, sondern als "Schönheit", die auf einer Reihe von Produkten reproduzierbar wird. Eine Kunst, die nicht nur bestaunt werden, sondern auch genutzt werden kann. Im Jahr 2020 wurden zwei Werke von Gillo Dorfles in die ständige Sammlung für Kunst und Design des Quirinale (Residenz des Präsidenten der Italienischen Republik) aufgenommen.

E\_Snowsound Art es un proyecto de Caimi: un viaje que permite explorar nuevos caminos que compagan ARTE y DISEÑO. Una forma de concebir el arte que no solo es una creación única e irrepitable, sino también una "belleza" replicable en objetos en serie. Un arte que se admira al tiempo que se disfruta. En 2020 dos obras de Gillo Dorfles entraron a formar parte de la colección permanente de Arte y Diseño del Palacio del Quirinale (la residencia del Presidente de la República Italiana).



**ENORMOUS DESIGN**  
Gillo Dorfles



**DESIGN CLUES**  
Sezgin Aksu

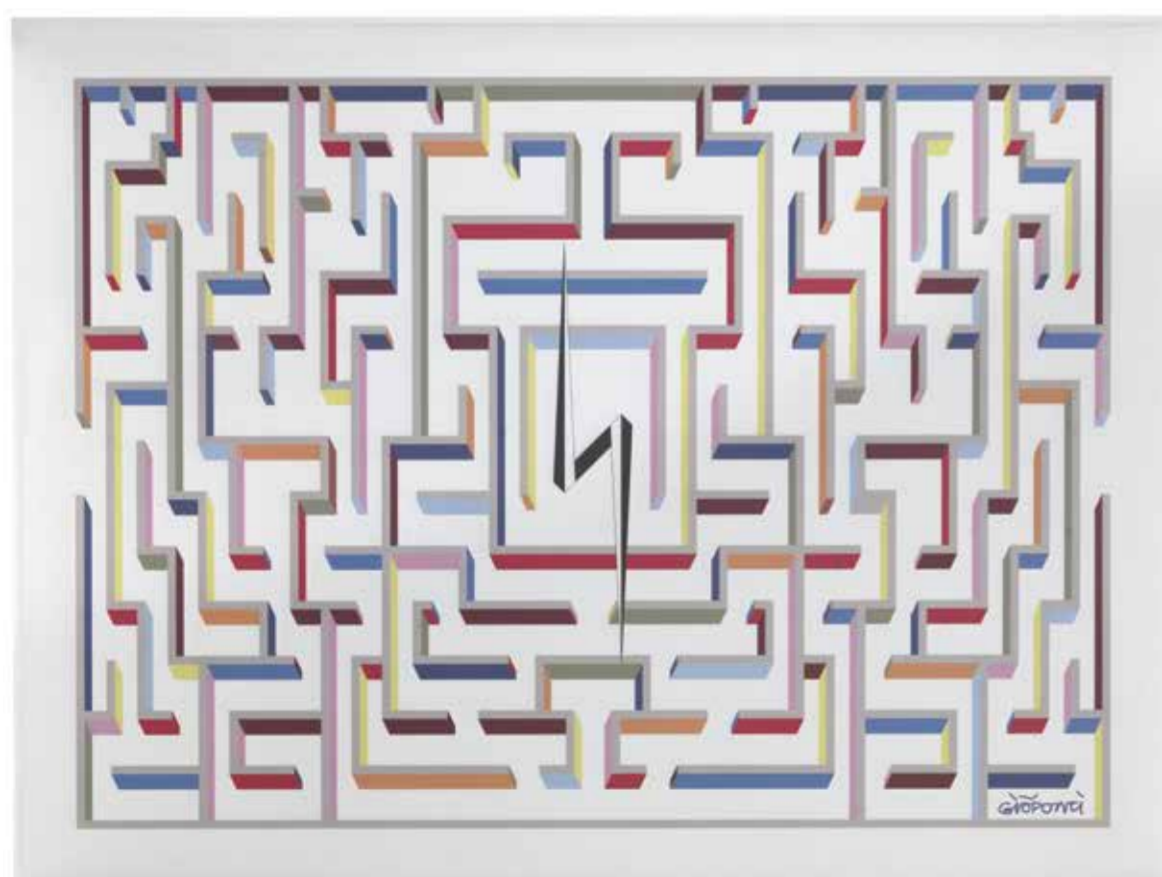

**THE SPLENDOR OF FUTURE**  
design by Gio Ponti



**IDEAS, THINGS**  
Alessandro Mendini



# Offices & Call centers



Gensler, Miami (U.S.A.)



NGC Medical, Turate CO (Italy)



SONY, CBRE Building, Chicago (U.S.A.)



SAP, Roma (Italy)



Hjelle, Oslo (Norway)



Würth Elektronik Italia, Vimercate MB (Italy)



Convey, Miramar (U.S.A.)



Nasdaq OMX, Paris (France)



Microsoft (Italy)



Criteo, Milano (Italy)



Office, design by AECOM, Los Angeles (U.S.A.)



Rapt Studio, San Francisco (U.S.A.)



Confartigianato, Vicenza (Italy)



Xerox (Italy)



Offices & Call-centers references

# Public spaces & Museums



Civic Center, Miami (U.S.A.)

# Education & Schools



Babson College, Jeddah (Saudi Arabia)

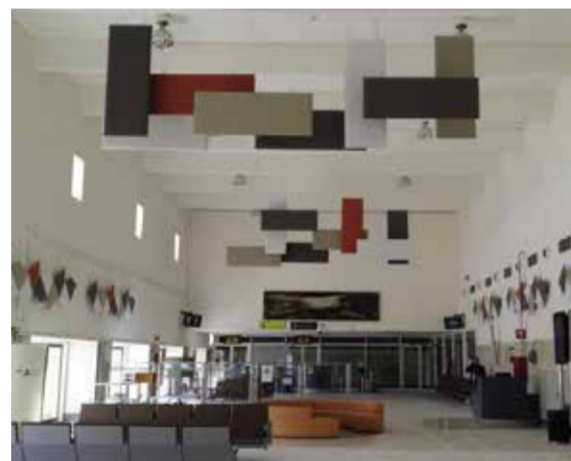

Seville Airport (Spain)



American Airlines (U.S.A.)



University of Miami (U.S.A.)



Business School, London (UK)



Università Bocconi, Milano (Italy)



DNK, Assen (Netherlands)



Villa Necchi Campiglio, FAI Fondo Ambiente Italiano, Milano (Italy)



MAXXI, Roma (Italy)

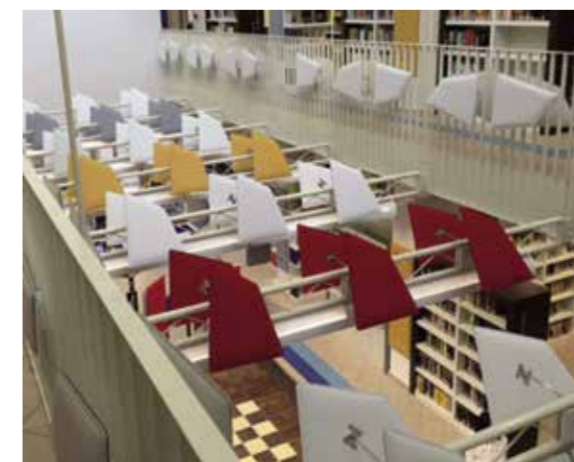

Biblioteca Mario Luzi, Firenze (Italy)



Politecnico di Milano (Italy)



CalTech California Institute of Technology, Pasadena (U.S.A.)



Riminibanca (Italy)



Public spaces & Museums references



Education & Schools references

# Healthcare



Ospedale di Perugia (Italy)

# Retail & Leisure



Gioielleria De Giorgio (Italy)



Casa di cura Parco dei Tigli, Padova (Italy)



Hsr Hospital, Milano (Italy)



Fondazione Umberto Veronesi (Italy)



Garage, Fargo (U.S.A.)



WOM by Audio Visual Group, Las Vegas (U.S.A.)



Ospedale San Giuseppe, Empoli (Italy)



IEO, Milano (Italy)



Hôpital de Vannes (France)



Healthcare references



Retail & Leisure references



Personaltraining studio, Reggio Emilia (Italy)



Stiz, taglio e colore, Rovereto TN (Italy)

# Restaurants, Cafes & Hotels



Print Restaurant, New York (U.S.A.)



Alla Piazza Koya, Ravenna (Italy)



Identità Golose, Milano (Italy)



Fragranze pizzeria, Chieti (Italy)



L'Amo, Arezzo (Italy)



La Virgule, Chaury (France)



Verdipapir Sentralen, Oslo (Norway)



Starbucks, Chicago (U.S.A.)



Arnoldo Mondadori Editore, Segrate MI (Italy)



Tre Farine, Aversa CE (Italy)



Dal Corso, Verona (Italy)



Restaurant Chai, Gembloux (Belgium)



Rand Merchant Bank, Johannesburg (South Africa)



Restaurants,  
Cafes & Hotels  
references



BNP Paribas (France)

# Home



Private house, Nebraska (U.S.A.)

# Audio & Music



Teatro della Triennale, Milano (Italy)



Private house (U.S.A.)



Private house, Napoli (Italy)



Theater, Lido di Venezia (Italy)



Auditorium, Hamburg (Germany)



New Horizon School, Irvine (U.S.A.)



Private house, Milano (Italy)



Private house (Germany)

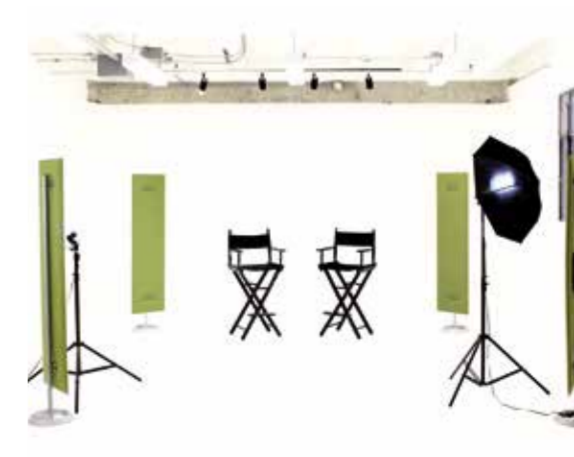

CTRL, Los Angeles (U.S.A.)



Studi televisivi RAI (Italy)



Private house, Roma (Italy)



Private house, Pelican Lake (U.S.A.)



Radio Yacht, Capri NA (Italy)



Home references



Audio & Music references



# SUSTAINABILITY & NO-PROFIT RESEARCH

## Environmentally conscious design & social sustainability

I\_Caimi, da sempre sensibile nei confronti delle tematiche ambientali e dell'ecosostenibilità, utilizza, dove tecnicamente possibile, materiali riciclabili o riutilizzabili. I prodotti Snowsound Technology, i tessuti Snowsound Fiber e Snowall hanno ricevuto la certificazione Greenguard Gold, che convalida le loro caratteristiche di bassa emissione ed il loro contributo alla qualità dell'ambiente. Nell'ottica della sensibilità per il sociale da sempre presente nel DNA della nostra società, l'operatività dei laboratori Open Lab non è un'esclusiva della Caimi, ma costituisce una struttura NO PROFIT messa a disposizione di Università, Istituti di Ricerca, Fondazioni ed Enti che ne possono usufruire per studi e ricerche, in special modo nel campo del suono e dell'acustica, al fine di individuare nuove soluzioni per il miglioramento della salute e del benessere psicofisico delle persone.

EN\_Caimi has always had an attentive eye for environmental issues and ecosustainability. This is why, if technically feasible, we use recyclable or reusable materials. Snowsound Technology, Snowsound Fiber fabrics and Snowall products have received Greenguard Gold certification, indicating that they are low emitting products and do contribute to improve indoor air quality. In keeping with the Company's deeply rooted commitment to open engagement with society, Open Lab doesn't not work exclusively on behalf of Caimi, but also serve as a non-profit facility at the disposition of universities, research institutes, foundations and public bodies, which may use the laboratories for study and research purposes, especially in the field of sound and acoustics, and in their search for new ways of improving human health and psychophysical wellbeing.

F\_Caimi, depuis toujours sensible aux thématiques de l'environnement et de l'éco-durabilité, utilise, quand c'est techniquement possible, des matériaux recyclables ou réutilisables. Les produits Snowsound Technology, les tissus Snowsound Fiber et Snowall ont reçu la certification Greenguard Gold qui confirme leurs caractéristiques de faible émission et donc leur apport à la qualité de l'environnement. Dans le respect de la sensibilité sociale, depuis toujours présente dans l'ADN de notre entreprise, les laboratoires Open Lab ne seront pas exclusivement limités à Caimi, mais formeront une structure SANS BUT LUCRATIF mise à la disposition des Universités, des Instituts de recherche, des Fondations et des Organismes qui pourront l'utiliser pour des études et des recherches, notamment dans le domaine du son et de l'acoustique, afin d'identifier de nouvelles solutions pour l'amélioration de la santé et du bien-être psychophysique des personnes.

D\_Caimi ist seit jeher mit Umweltthemen und der Umweltverträglichkeit vertraut und verwendet, wo technisch möglich, wiederverwertbare oder recyclebare Materialien. Die Produkte Snowsound Technology, die Snowsound Fiber Stoffe und Snowall sind mit der Greenguard Gold-Zertifizierung ausgezeichnet worden, die die Anwendung von Materialien mit geringen chemischen Emissionen und deren Beitrag zur verbesserten Raumqualität bezeugt. Im Einklang mit der im Unternehmen tief verankerten Überzeugung des offenen Engagements mit der Gesellschaft, werden die Open Lab-Labors nicht ausschließlich Caimi dienen, sondern als gemeinnützige Einrichtung Universitäten, Forschungsinstituten, Stiftungen oder Behörden zur Verfügung stehen, die sie für Untersuchungen und Forschungen nutzen können werden, insbesondere um neue Lösungen im Bereich von Akustik und Schall zu entwickeln, die zur Besserung von Gesundheit und körperlichem und geistigem Wohlbefinden der Menschen beitragen.

E\_Caimi, desde siempre sensible con los temas medioambientales y la ecosostenibilidad, utiliza siempre que sea técnicamente posible materiales reciclables o reutilizables. A los productos Snowsound Technology, los tejidos Snowsound Fiber y Snowall se les ha otorgado el certificado Greenguard Gold, que garantiza sus características de baja emisión y su contribución a la calidad del ambiente. Nuestra empresa siempre tuvo en su ADN una atención especial por el ámbito social y por ello, la actividad de los laboratorios Open Lab, no será algo exclusivo de Caimi sino que se creará una estructura SIN FINES DE LUCRO al servicio de las Universidades, Institutos de Investigación, Fundaciones y Entes para sus estudios e investigaciones, en particular en el ámbito del sonido y de la acústica, para identificar soluciones nuevas que mejoren la salud y el bienestar psíquico y físico de las personas.



Watch the video



**CAIMI BREVETTI S.p.A.**  
Via Brodolini, 25/27  
20834 Nova Milanese - MB - Italy  
Tel. 0362 49101  
info@caimi.com  
www.caimi.com

**Ufficio Vendite Italia**  
Tel. 0362 491001  
Fax 0362 491060  
vendite.italia@caimi.com

**Export Department**  
Tel. (+39) 0362 491002  
Fax (+39) 0362 491061  
export.dept@caimi.com

**Los Angeles Showroom**  
Helms Design Center  
8745 Washington Blvd, Studio C  
Culver City, CA 90232 USA

**Chicago Showroom**  
222 Merchandise Mart Plaza  
Floor 11, Suite 1197  
Chicago, IL 60654 USA

**U.S.A / Canada / Mexico**  
Snowsound USA  
10018 Santa Fe Springs Road  
Santa Fe Springs, CA 90670  
Tel. 562.903.9550  
info@snowsoundusa.com  
www.snowsoundusa.com

Follow us:



I\_Caimi Brevetti S.p.A. si riserva, a proprio insindacabile giudizio, la facoltà di modificare senza preavviso i materiali costruttivi, le caratteristiche tecniche ed estetiche, nonché le dimensioni degli elementi illustrati nel presente catalogo le cui immagini e colori sono puramente indicativi. Il testo facente fede è esclusivamente quello in lingua italiana, le traduzioni hanno la finalità esclusiva di semplificarne la lettura. Prima di procedere all'acquisto dei prodotti illustrati nel presente catalogo consultate le condizioni di vendita nonché le caratteristiche tecniche e le avvertenze riportate nel listino prezzi in vigore.

EN\_Caimi Brevetti S.p.A. reserves, by its unappealable judgment, the right to modify without prior notice the building materials, the technical and aesthetic specifications, as well as the dimensions of the products in this catalogue, where pictures and colours are purely as an indication. The authentic text is only in Italian, the translation has the mere purpose of simplifying the reading. Prior to purchasing the products in this catalogue please consult the sale conditions and also the technical specifications and warnings in the current price list.